

Nature and Science

ISSN 1545-0740

Volume 4 - Number 2 (Cumulated No. 9), May 10, 2006

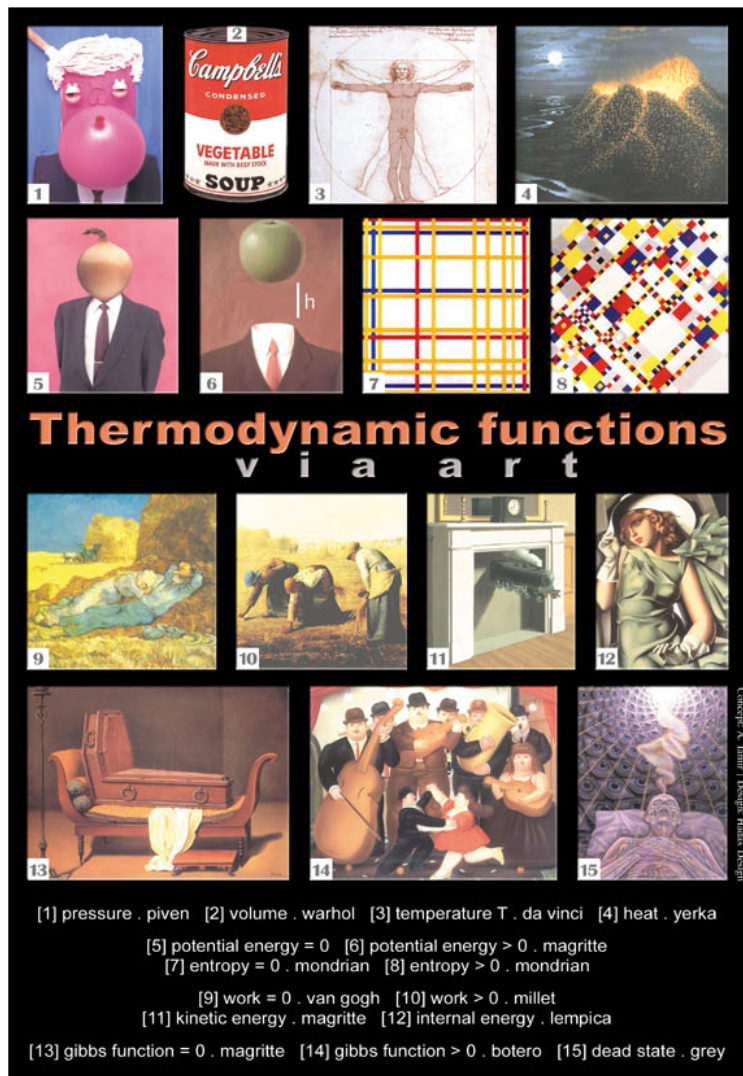

Nature and Science

The **Nature and Science** is an international journal with a purpose to enhance our natural and scientific knowledge dissemination in the world under the free publication principle. Any valuable papers that describe natural phenomena and existence or any reports that convey scientific research and pursuit are welcome, including both natural and social sciences. Papers submitted could be reviews, objective descriptions, research reports, opinions/debates, news, letters, and other types of writings that are nature and science related. The journal is calling for papers and seeking co-operators and editors as well.

Editor-in-Chief: Hongbao Ma

Associate Editors-in-Chief: Qiang Fu, Yongsheng Ma, Margaret Young

Editors: George Chen, Shen Cherg, Mark Hansen, Mary Herbert, Wayne Jiang, Xuemei Liang, Mark Lindley, Mike Ma, Da Ouyang, Xiaofeng Ren, Shufang Shi, Tracy X Qiao, George Warren, Qing Xia, Yonggang Xie, Shulai Xu, Lijian Yang, Yan Young, Tina Zhang, Ruanbao Zhou, Yi Zhu

Web Design: Yan Young

Introductions to Authors

1. General Information

(1) Goals: As an international journal published both in print and on internet, *Nature and Science* is dedicated to the dissemination of fundamental knowledge in all areas of nature and science. The main purpose of *Nature and Science* is to enhance our knowledge spreading in the world under the free publication principle. It publishes full-length papers (original contributions), reviews, rapid communications, and any debates and opinions in all the fields of nature and science.

(2) What to Do: The *Nature and Science* provides a place for discussion of scientific news, research, theory, philosophy, profession and technology - that will drive scientific progress. Research reports and regular manuscripts that contain new and significant information of general interest are welcome.

(3) Who: All people are welcome to submit manuscripts in any fields of nature and science.

(4) Publication Costs: There is no publication fee by the authors.

(5) Journal Copies to Authors: Each hard copy of the journal will be charged for US\$60 to cover the printing and mailing cost.

(6) Distributions: Web version of the journal is freely opened to the world without any payment or registration. The journal will be distributed to the selected libraries and institutions for free. US\$80/issue hard copy is charged for the subscription of other readers.

(7) Advertisements: The price will be calculated as US\$400/page, i.e. US\$200/a half page, US\$100/a quarter page, etc. Any size of the advertisement is welcome.

2. Manuscripts Submission

(1) Submission Methods: Electronic submission through email is encouraged and hard copies plus an IBM formatted computer diskette would also be accepted.

(2) Software: The Microsoft Word file will be preferred.

(3) Font: Normal, Times New Roman, 10 pt, single space.

(4) Indent: Type 4 spaces in the beginning of each new paragraph.

(5) Manuscript: Don't use "Footnote" or "Header and Footer".

(6) Cover Page: Put detail information of authors and a short title in the cover page.

(7) Title: Use Title Case in the title and subtitles, e.g. "Debt and Agency Costs".

(8) Figures and Tables: Use full word of figure and table, e.g. "Figure 1. Annual Income of Different Groups", "Table 1. Annual Increase of Investment".

(9) References: Cite references by "last name, year", e.g. "(Smith, 2003)". References should include all the authors' last names and initials, title, journal, year, volume, issue, and pages etc.

Reference Examples:

Journal Article: Hacker J, Hentschel U, Dobrindt U. Prokaryotic chromosomes and disease. *Science* 2003;301(34):790-3.

Book: Berkowitz BA, Katzung BG. Basic and clinical evaluation of new drugs. In: Katzung BG, ed. Basic and clinical pharmacology. Appleton & Lance Publisher. Norwalk, Connecticut, USA. 1995:60-9.

(10) Submission Address: editor@sciencepub.net, naturesciencej@gmail.com; Marsland Company, P.O. Box 21126, Lansing, Michigan 48909, The United States, 517-980-4106.

(11) Reviewers: Authors are encouraged to suggest 2-8 competent reviewers with their name and email.

2. Manuscript Preparation

Each manuscript is suggested to include the following components but authors can do their own ways:

(1) Title page: including the complete article title; each author's full name; institution(s) with which each author is affiliated, with city, state/province, zip code, and country; and the name, complete mailing address, telephone number, facsimile number (if available), and e-mail address for all correspondence.

(2) Abstract: including Background, Materials and Methods, Results, and Discussions.

(3) Key Words.

(4) Introduction.

(5) Materials and Methods.

(6) Results.

(7) Discussions.

(8) References.

(9) Acknowledgments.

Journal Address:

Marsland Company

P.O. Box 21126

Lansing, Michigan 48909

The United States

Telephone:(517) 980-4106

E-mail: naturesciencej@gmail.com; editor@sciencepub.net

Homepage: <http://www.sciencepub.org>

Nature and Science

ISSN 1545-0740

Volume 4 - Number 2 (Cumulated No. 9), May 10, 2006

CONTENTS

1. The Resurrection of the Light Conducting Medium for Modern Physics

Ken H. Seto

11. A Theoretical Approach to the Overall Control of the Nervous System in Human Beings

Sum-Wah Lam

18. New Explorations to Hawking Radiation With Classical Theories

Dongsheng Zhang

23. On the Parabolic Curve of Primary Mirrors

Kyle DeGrave

25. Philosophical implications of Universal Theory of Relativity: Role of God in the Universe, Time, Determinism, Quantum Mechanics

Javed Jamil

31. The Museum of Art and Science of Ben-Gurion University of the Negev, Beer-Sheba, Israel and a Few Responses of Visitors

Abraham Tamir

34. Thermodynamic Functions via Art

Abraham Tamir

36. ELISA Technique

Hongbao Ma, Kuan-Jiunn Shieh

38. Torque Teno Virus (TTV) Infection In Egyptian Patients with Chronic Liver Disease and Hepatocellular Carcinoma

Maisa Omar, Nevine Fam, Samah Saad El-Din, Mahmoud Romeih , Hanem Mohamed, Moatez Hassan, Ibrahim Mostafa, Afkar Badawy, Maha Akl, Mohamed Saber

46. Timed Colored Petri Nets Based Modelling and Scheduling of Aero-engine maintenance
Xinmin Tang, Shisheng Zhong**52. Properties of Recombinant *Sulfolobus shibatae* Maltooligosyltrehalose Synthase Expressed in HMS174**

Wen Shen, Jin Wu, Jinfu Wang, Yanhe Ma, Ziyuan Duan, Yifeng Gong

58. Ten-minute DNA Release Kits - A novel approach to obtain DNA easily in modern biological science

Huaijie Zhu, Yucui Zhu, Hongbao Ma

71. Complex number

Wikipedia, the free encyclopedia

79. Wikipedia: The Free Encyclopedia

Ma Hongbao

92. Introduction93. Call for Papers

Marsland Company
P.O. Box 21126
East Lansing, Michigan 48909
The United States
Telephone:(517) 980-4106
E-mail: naturescience@gmail.com
Homepage: <http://www.sciencepub.org>

The Resurrection of the Light Conducting Medium for Modern Physics

Ken H. Seto

KHS Publishing, 260 Yorkshire Lane, Xenia, OH 45385, USA
kenseto@erinet.com; <http://www.erinet.com/kenseto/book.html>
Telephone: 937-3725298

Abstract: Physicists at the times of Isaac Newton and James Clerk Maxwell perceived that space is occupied by a light-conducting medium called 'aether.' The motions of objects in this medium are called absolute motions. However, when Michelson and Morley failed to detect this light-conducting medium with their famous MMX experiments, physicists began to doubt the existence of aether. This doubt was reinforced when Einstein developed his Special Theory of Relativity (STR). With STR, Einstein demonstrated that the need for an aether is 'superfluous' and that motions relative to it are not detectable. This led physicists to conclude that even if there is an aether occupying space it plays no role in the any of the processes of nature. This conclusion led physicists to resort to the non-physical mathematical constructs such as space-time, time dilation, rod contraction, duality, virtual particles, fields, probability waves, and curled up extra dimensions to explain the processes of nature. The irony is that these mathematical constructs are just thinly disguised aether effects. This method of doing physics has had severe adverse consequences. It led generations of physicists to develop a mind set against the aether concept. [Nature and Science. 2006;4(2):1-10]

Keywords: resurrection; light conducting medium; physics; aether

Contents

1. Introduction
2. The Current State of Our Universe
3. The Concept of Absolute Motion
4. Past Experiments Detected Absolute Motion
5. New Experiments to Detect Absolute Motion
6. Conclusions

of the E-Matrix is such that it explains the weird results of the following past famous experiments: the Compton Effect Experiment, the Photoelectric Experiment and the Double-Slit Experiment. Also the E-Matrix allowed me to design two new experiments that are capable of detecting the absolute motion of the observer in the E-Matrix. The following topics of discussion reveal the power of the E-Matrix concept.

1. Introduction

This paper describes a unique aether called the E-Matrix. The unique properties of the E-Matrix give new simple interpretations for the weird results of past famous quantum experiments. Also, they allowed me to develop two new experiments to detect its existence. The existence of the E-Matrix opens up new alternatives for doing physics. Most importantly, it gives us a new way to explain and unify all the forces of nature.

Quantum Mechanics and Relativity are the most successful theories of modern physics. However, these two pillars of modern physics are not compatible with each other at the fundamental level. The main point of incompatibility is that there is no viable theory of quantum gravity. In recent years there is a resurgent of interest in the aether approach for doing physics. This paper describes the successful development of a unique aether called the E-Matrix Ref. [1]. The unique structure

2. The Current State of Our Universe

In the past, great advances were made when physicists encountered problems with their existing theories. A good example of this was Max Planck's discovery of the light quanta. At that time, light was considered to be continuous waves and this concept gave rise to the problem called the *ultraviolet catastrophe*. As it turned out, Max Planck's ideas not only were able to explain the *ultraviolet catastrophe* but they also started the revolution that led to quantum mechanics. Another example was Einstein's theory of relativity. Before relativity, Newton's laws of motion reigned. When physicists realized that Newton's theory could not properly describe light, they adapted Einstein's theory of relativity.

Today Quantum Mechanics (QM) and Relativity are two of the most successful theories in the history of

physics. Yet, they can only be referred to as partial theories because each by itself is not capable of describing or uniting all the forces of nature. The problems of uniting all the forces of nature present a challenge similar to that of the pre-relativity and pre-quantum mechanics days. However, in spite of intense efforts for the past seventy years, all attempts to describe gravity using the quantum mechanical processes have failed. This could be a symptom that both QM and Relativity are fundamentally flawed. In other words, the state of the current universe as set forth by QM and Relativity may not be the true description of nature. This suggests that a new description of the current universe may be needed for us to get out of our present conundrum.

I developed an interest to develop a unify theory in the early 1980's. At first, I followed the conventional approach of building on top of current theories. However, after many years of fruitless efforts, I came to the conclusion that this approach is ultimately doomed to fail because QM and Relativity are not based on the true model of the current universe. In the late 1980's, I abandoned the conventional approach for doing physics and started using an approach called the *Pyramid Techniques*. As the name implies, the *Pyramid Techniques* assumes that there is only one description of the current universe that is capable of explaining all the processes of nature. This description is at the apex of the pyramid. The step-by-step procedure for the *Pyramid Techniques* is as follows:

1. Search the literature and identify the major problems of relativity, quantum mechanics and modern cosmology.
2. Formulate a group of theories that can account for these problems. The formulator is free to assume any model of the current state of the universe. The resulting group of theories must be capable of explaining all the processes of nature. During the formulation process, the formulator must adhere to the fundamental principle that all particles in the universe are dumb. However, their motions in space could give the appearance of them possessing 'intelligent' properties. I named the resulting group of theories *Model Mechanics* to emphasize the processes used to derive these theories.
3. The next step is to check the consistency of the postulates of the formulated theories with past observations and experimental results. Specifically, include those results and observations that can support the new theories exclusively.

4. Design realistic experiments that can confirm the newly formulated theories.
5. Develop the equations based on the newly formulated theories. Except for Doppler Relativity Theory, *Model Mechanics* is at this stage of development.
6. Perform the designed experiments for the final confirmation.

The *Pyramid Techniques* enabled me to go through a number of possible states of the current universe quickly. The first model that was somewhat successful posits that space is filled with a substance called the E-Matrix (the prefix "E" represents elastic). The E-Matrix exerts a repulsive force on all the matter particles within it. In other words, a particle in the E-Matrix is much like a droplet of oil emulsion in water--it feels the repulsive force of the water from all sides. When the E-Matrix is distorted, it will recover itself to the original non-distorted state quickly. Light is waves in the E-Matrix and time is absolute, not flexible, as postulated by the Special Theory of Relativity (STR). This model of the universe explains the propagation of light but it was not capable of explaining the various force interactions without resorting to abstract processes; therefore, it was not a successful model.

As a means of increasing the scope of this model, I visualized that the E-Matrix is composed of E-Strings. These E-Strings are three-dimensional elastic strings and they are oriented randomly in all directions. The motions of matter particles in the E-Matrix will distort the geometry of the E-Strings locally. On the other hand, matter particles will follow the local geometry of the E-Strings (due to orbital confinement) as they travel in the E-Matrix. This modified model brings General Relativity into the fold. However, it lacked the processes to describe the electromagnetic, nuclear weak and strong forces. It was evident that additional modifications were needed to explain these interactions. The next idea that I added to the above model is one of the most important ideas of *Model Mechanics*. This idea posits that all the forces of nature are the results of absolute motions between the interacting particles or particle systems. These modifications completed the modeling process and yield the following successful description of the current state of our universe:

A stationary substance called the E-Matrix occupies all of the pure-space in our universe. Subsequently, we perceive the E-Matrix as space. The E-Matrix, in turn, is composed of E-Strings. An E-String is a very thin three-dimensional elastic object. The diameter of an E-String is not defined. It is probably in the region of Planck length, which is defined as the smallest length that has any meaning. The length of an E-String is not defined. It could be a big loop and in that case the diameter of the loop is defined. Away from matter, E-Strings are

oriented randomly in all directions, but near matter, E-Strings are more organized: some emanate from the matter, and the number of these passing through a unit area at a distance 'r' from the matter is inversely proportional to r^2 . Matter particles will follow the local geometry of the E-Strings as they travel in the E-Matrix. In turn, the motions of matter particles in the E-Matrix will distort the geometry of the E-Strings locally. These provisions of the E-Matrix are responsible for the peculiar properties of the gravitational force. Also, it explains why the propagation of light and gravity obeys the inverse square law.

The E-Strings are repulsive to each other. This repulsive effect is fundamental. This means that there is a compacting force served to compact the E-Strings together to form the E-Matrix. This compacting force is also fundamental. The compacting force and the repulsive force between the E-Strings are in a delicate equilibrium and this equilibrium is self-restoring when the motion of particles in the E-Matrix disturbs it.

With this description of the E-Matrix, the next relevant question is: What is matter? The answer to this question is: All matter is making from a fundamental particle called the S-Particle. The different orbiting motions of the S-Particles around the E-Strings give rise to all the observable particles such as the electron and the different quarks. Also, the different orbiting motions of the S-Particles give rise to the extrinsic properties such as charge, spin and mass of the observable particles. The S-Particle is a 3-dimensional entity. Its internal structure is not defined. It has no intrinsic property. The diameter of an S-Particle is not defined but it is likely in the range of Planck length (10^{-33} cm). The S-Particles and the E-Strings are exerting a repulsive force on each other and this force is fundamental. This allows the S-Particles to move unimpeded in the E-Matrix. The different directions of absolute motions of the S-Particles or S-Particle systems give rise to all the forces of nature.

The above Model Mechanical description of the current universe appears to be conflicting with the results of some past experiments. Specifically, it appears to be conflicting the null result of the Michelson and Morley experiment (the MMX). Physicists concluded that the null result of the MMX suggests that there is no light conducting medium (aether) occupying space. This is in direct conflict with the proposed E-Matrix, which is a form of aether. It turns out that the MMX results can be interpreted differently. This new interpretation leads to a new conclusion: Michelson and Morley did indeed detect the aether that they were seeking. The following is a description of this new interpretation.

A New Interpretation of the MMX

Maxwell's physics suggests that space is occupied by a light-conducting medium, which he called "aether." Michelson and Morley designed an experiment (the MMX) to find this *aether*. They use interferometer to compare the speed of light in the direction of the earth's 30-km/sec motion around the sun with that at right angles to this motion. To their surprise, they found no fringe shift, indicating that the speed of light was the same in all directions. This result is known as the MMX null result. In spite of the null result of the MMX, Michelson remained a firm believer in the existence of aether until his death. However, his belief did not stop other physicists from concluding that the MMX null result meant that there was no aether occupying space. For reasons developed below it is likely that this conclusion is erroneous.

Michelson and Morley made the following assumptions at the start of their experiment:

1. The aether is a fluid and this fluid is flowing through their instruments.
2. The relative motion between the earth and the sun was interpreted as the absolute motion of their instrument in the aether.
3. Light travels slower against the direction of flow of this fluid (somewhat like moving against a head wind) and it travels faster in the transverse direction in this fluid.
4. The different light speeds between the two right-angled directions will show up as a fringe shift.

Today, we know that assumptions 1, 2 and 3 are false. Assumption 1 assumed a structure of aether that is not compatible with the source-independence of light speed, which requires a stationary solid aether (the E-Matrix). Assumption 2 is wrong because the earth-sun system travels in the Milky-Way galaxy, and the galaxy travels in space. Assumption 3 is wrong because the speed of light has been proven experimentally to be independent of the state of motion of the source. This experiment was performed at CERN in 1964 with a stream of neutral pion subatomic particles. Light from the decay of pions at rest was found to have the same speed as light from the decay of pions moving at a speed close to that of light. The falsities of these assumptions suggest that the no-aether conclusion may have been false too.

If Michelson and Morley had known that light speed is independent of the state of motion of the source they might have concluded that they had found the aether that they were seeking. This alternate conclusion is based on the following analysis:

1. The mirrors at the end of the arms were acting as sources. Due to the source-independence of the speed of light, pulses from these different sources travel with the same constant speed toward their common target, the half-silvered mirror that recombines them. This means that the light rays arrive at the common target in phase and thus give rise to the null result of the MMX.
2. The MMX confirmed the source independence of the speed of light.
3. Source-independence of the speed of light supports the idea that light is a wave pattern in a transmitting medium and that medium is called aether.
4. The aether 'yes' interpretation of the MMX represents a support of the existence of the E-Matrix. We are now justified to use the E-Matrix and the absolute motion of S-Particles or S-Particle systems in the E-Matrix to explain all the processes of nature. Specifically, it provides us with a mean to unify all the forces of nature. It explains why the speed of light is constant in all inertial frames. It explains what is time dilation and length contraction. It gives the cause of gravity and explains the meaning of the observed action at-a-distance phenomenon of gravity.
5. motions possessed by the S-Particles in the E-Matrix.
3. The V_{se} motion stands for the orbiting motion of the S-Particle of an electron. This motion is the fastest of all the motions possessed by the S-Particles in the E-Matrix. It is responsible for a full unit of electric charge. This motion also had its origin from the Big Bang.
4. The V_{suq} motion stands for the orbiting motion of the S-Particle of an up quark. This motion is the second fastest of all the motions possessed by the S-Particles in the E-Matrix. It has a value of $2/3$ of that of V_{se} and thus it gives rise to a $2/3$ unit of electric charge. This motion also had its origin from the Big Bang.
5. The V_{sdq} motion stands for the orbiting motion of the S-Particle of a down quark. This motion is the third fastest of all the absolute motions possessed by an S-Particle in the E-Matrix. It has a value of $1/3$ of that of V_{se} and thus it gives rise to a $1/3$ unit of electric charge. The absolute motion of the down quark's S-Particle is the product of annihilation of the S-Particle of an electron (V_{se}) and the S-Particle of an up-quark (V_{suq}) immediately after the Big Bang. In this process, the electron became a down quark and the up quark became a free S-Particle.

3. The Concept of Absolute Motion

The idea of absolute motion within the observer's frame is hard to visualize. This is because our perceptions of objects surrounding us are stationary unless there is an external force acts upon them. We can get rid of this visualization problem by remembering that absolute motion is not relative to us but it is relative to the E-Matrix. The following is a list of five basic absolute motions that exist in our universe. These include the absolute speed of light and those absolute motions that are possessed by the various S-Particles in the E-Matrix. The interactions of these five basic absolute motions of particles in the E-Matrix give rise to all the other absolute motions that are observed in our universe.

1. The absolute speed of light in the E-Strings is maximum when it is determined using a defined *absolute* second in the E-Matrix.
2. The V_{bb} (Velocity Big Bang) motion is an absolute motion possessed by all the S-Particles in the E-Matrix. It is this motion that is responsible for the attractive component of gravity. The V_{bb} motion had its origin from the Big Bang. It is the slowest of all the absolute

4. Past Famous Experiments Detecting Absolute Motion

Special Relativity Theory posits that the absolute motion of a body is not detectable within the frame of the body. This had led some physicists to conclude that absolute motion does not exist. This, in turn, had led these physicists to avoid the use of absolute motion at all cost in their formulation processes. However, the following new interpretations of the Compton Effects, the Double-Slit and the Photoelectric experiments suggest that absolute motion does indeed exist and that it was the cause of the weird results of these experiments.

The Compton Effect Experiment

The experimental set up for the Compton Effect Experiment is simple. It consists of an incident x-ray source that aims at a graphite target. The wavelengths of the scattered rays are measured at the various deflection angles. The results of this experiment showed that the scattered x-rays have intensities peaked at two wavelengths. One peaked at the same wavelength as the incident x-ray and the other peaked at a longer wavelength (red-shifted) than the incident x-ray. The difference between the two wavelengths is called the Compton Shift. Also, the Compton Shift increases as the scattering angle increases.

Current Interpretation of the Compton Experiment

The current interpretation of the Compton results is as follows: The peak that has the same wavelength, as the incident x-ray is the result of photons colliding with the combined electrons of the carbon atom. Each of these combined electrons has an effective mass of 22,000 electron mass. Therefore, a photon colliding with it will retain almost all of its energy after the collision. With this process the observed wavelength shift from the incident wavelength would be immeasurably small. Therefore, we have a peak that has approximately the same wavelength as the incident x-ray. The other peak represents the result of photons losing some of their energy by colliding with the free electrons. After the collisions, these photons would have lost some of their energy and resulted in their longer wave lengths and thus, they would appear as being red-shifted. These interpretations are considered to be the proofs of the particle nature of light.

New Interpretation of the Compton Experiment

The absolute motion of the graphite target relative to the incident beam causes the red shifted peak. The other peak is due to the normal absorption and re-emission process by the orbiting electrons. This immediately raises the question: Why is that the Compton experiment gives the same results regardless of the direction from which the incident x-ray beam is coming? The answer to this question is: On earth, all targets in the same horizontal plane have the same upward or downward receding absolute motion relative to the horizontal incident x-ray beam. This relationship between the targets and the incident light beam gives rise to the Lorentz Factor. Also, this is why all light propagation equations contain the Lorentz Factor. The other relevant questions and answers for this new interpretation are as follows:

1. What is the process that causes the frequency shift? The answer to this question is: The red shifted peak is the reflection of the incident x-ray by the carbon nuclei that are in a state of upward or downward receding absolute motion. This process is the same as bouncing a radio beam off a receding object. The return beam is found to be red shifted.
2. The electrons are also in the same state of absolute motion as the nuclei, why is the x-ray coming from them is not red shifted? The answer to this question is as follows: The processes of absorption and the re-emission of x-ray by an electron are not reflective processes. Each transition of an electron requires the absorption of a specific amount of energy from the E-Matrix surrounding it. The re-emission process is the reverse. The electron

must give up the same amount of energy to return to the original energy state. These processes are not sensitive to the state of absolute motion of the electrons. This means that the re-emitted beam will have the same energy state as the incident beam and thus there is no frequency shift for the re-emitted beam.

The Double-Slit Experiment

The double-slit experiment is the most puzzling of all the quantum experiments. It has been said that if one understands the results of the double-slit experiment, one knows quantum mechanics. This experiment confirms the wave nature of particles and light. The apparatus set-up is simple. It consists of a light or particle source and the beam is directed at a double-slit opening. In the case of the electronic version of this experiment, the double-slit is in the form of an atomic crystal grating. The image of the fringes is recorded on a screen at a specific distance from the partition. In the case of using an electron beam the screen is composed of a bank of Geiger counters.

When this experiment was performed with light, the results were characteristic light and dark fringes on the screen. These results were obtained even if only one photon (a light packet) at a time is sent through the apparatus. When the electronic equivalent of this experiment was performed, the same results of characteristic light and dark fringes were obtained.

Current Interpretation of the Double-Slit Experiment

The current accepted interpretation of the results of the double-slit experiment is known as the Copenhagen Interpretation. The Copenhagen Interpretation is undoubtedly the most abstract of all quantum mechanical processes. The results for a light beam are easy to understand. It is simply that light waves go through both slits and spread out--much like water waves spread out after they go through a narrow opening. A light fringe would be the result of those spread-out waves that were in phase and therefore they reinforced each other and showed up as a light fringe on the screen. A dark fringe would be the result of these spread-out waves that were out of phase with each other. Therefore, they interfered and canceled each other out and showed up as a dark fringe on the screen. The results for an electron beam are a little harder to understand. However, they are the same as that for the light beam except that the electrons must somehow become electron-waves when they go through the slits. These electron-waves reinforced or interfered with each other much like the light waves. However, after the interference processes, these electronic waves must

reconstitute themselves back into the particle electrons before hitting the screen. This process is known as the collapse of the wave function.

The processes of fringe formation by a single photon or electron are much more complex and abstractive. The current interpretation is as follows: A photon or electron becomes a wave function of probability waves and goes through both slits. These probability waves interfere with each other--much like the water waves. These probability waves are mathematical constructs and therefore they have no physical meaning. After the interference processes, these probability waves re-collapse into a photon or electron and register as such on the screen. The characteristic light and dark fringes on the screen will become apparent after a large number of these experiments are performed.

New Interpretation of the Double-Slit Experiment

The fringe patterns formed by a double-slit are not interference fringes. The absolute motion of the partition and the screen relative to the light or electron beams forms them. The stationary E-Matrix and that lights are waves in the E-Matrix are needed for this new interpretation. Figure 1 shows a schematic diagram of the light profiles generated when the partition and the screen are in a state of absolute motion. It is noteworthy that if the double-slit experiment were performed in the absolute rest frame of the E-Matrix, the fringe pattern on the screen would simply consist of two bright fringes of the slits.

The processes of dark or light fringe formation by a double-slit are as follows: The absolute motion of the partition and thus the center partition strip between the two slit openings is continuously exposing new light-wave carrying E-Strings to the two slit openings. Before these E-Strings move into the two slit openings, those portions of E-Strings that are between the center strip and the screen are wave-less. The reason is that the source side of the center partition strip will have already absorbed the light waves in them. Therefore, these wave-less portions of E-Strings will become two dark fringes on the screen (one on each side of the center partition strip). When the light carrying E-Strings are exposed to the slit openings, the light waves in them will travel toward the screen. They will become two light fringes when they arrive at the screen (one on each side of the center partition strip). These processes of dark and light fringe formation continue and the absolute motion of the screen will spread them out to give the final fringe pattern on the screen.

There is one relevant question with this explanation of the double-slit experiment: If absolute motion of the partition and the screen caused the light and dark fringe pattern, why isn't the pattern orientation dependent? The answer to this question is as follows: On earth, the partition and the screen are in an upward or downward state of absolute motion relative to the light rays in the horizontal plane. This means that the partition and the screen will have the same state of absolute motion relative to all the light rays in the same horizontally plane. Therefore, no effect on the fringe pattern will be observed by changing the horizontal orientation.

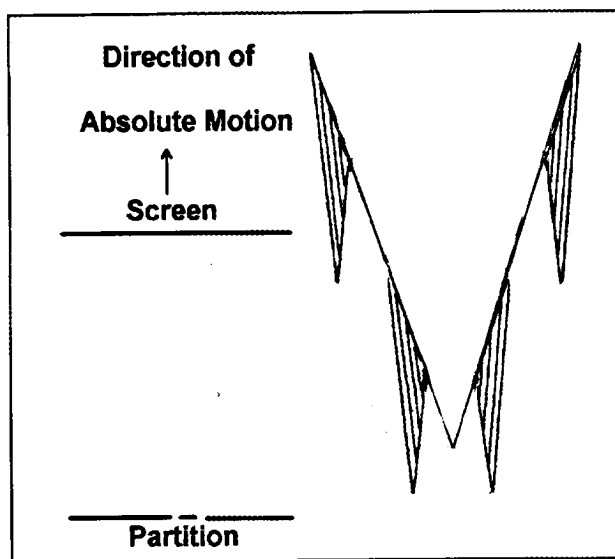

Figure 1. The light profile formed by a double-slit due to the absolute motion of the partition and the screen relative to the light or electron beam.

The above description of fringe formation is valid for all intensities of light or electron. In other words, even if one photon or electron is used for each experiment, the light and dark fringes will emerge after the same experiment is repeated a large number of times. This interpretation of the double-slit experiment eliminates the abstractive and counterintuitive processes of the Copenhagen Interpretation. Also this interpretation will give physicists a simpler way of doing physics.

Re-Interpreting the Photoelectric Effect Experiment

The wave nature of light can be easily demonstrated with the diffraction phenomenon. However, the results of the photoelectric experiment are not easily explained if light is just plain old continuous waves. The continuous light wave concept gives rise to the *ultraviolet catastrophe* problem. This problem was resolved with Max Planck's light quanta. The experimental set up for the photoelectric experiment is simple. It consists of a light source of varying intensities and varying high frequencies shining on a metal surface. The photoelectrons that are boiled off at the various intensities and frequencies are collected and their energy is measured. The results were as follows:

1. The energy of the photoelectron is dependent only on the frequency of the incident light.
2. The intensity of light has no effect on the energy of the photoelectron
3. Increasing the intensity of light will increase the number of photoelectrons being boiled off the metal surface.

Current Interpretation of the Photoelectric Experiment

The results of the photoelectric experiment suggest that light comes in discrete units. This led Einstein to conclude that light exists in discrete units instead of continuous waves and he called the individual unit a photon of light. However, a photon is not a true particle because it does not have all the attributes of a particle. It is more accurate to describe a photon as a wave packet or a very short pulse of light. This description of light along with Max Planck's light quantum formed the foundation of quantum mechanics. What is the mechanism that causes light to come as wave packets? Current physics provides no explanation to this question.

New Interpretation of the Photoelectric Experiment

Model Mechanics agrees with the current explanation that all lights come as wave packets. The reason light comes in this peculiar form instead of continuous waves has its origin from the fact that all light sources are moving absolutely in the E-Matrix. In a short specific increment of time, a light source will appear to emit light that is continuous. After this incremental time, the light source will have moved to a new location due to its absolute motion. This cuts off the continuity of waves and gives rise to a wave-packet of light. What this new interpretation says is: a photon is consisted of short blocks of light waves in neighboring E-Strings. These blocks of light waves travel coherently towards a common target and this has the effect of a particle hitting the target. With this new interpretation, we have a way to explain why light appears to have duality properties.

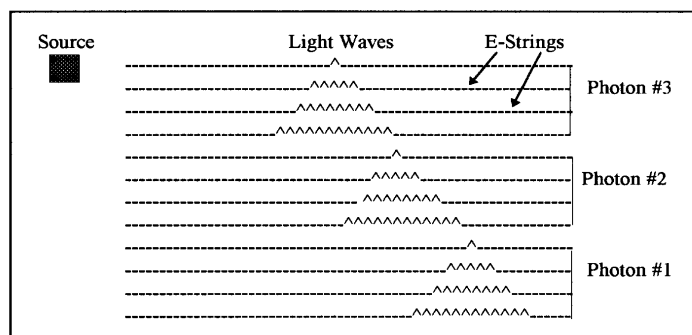

Figure 2. Schematic diagram of photon emission from a source that is in a state of absolute motion in the E-Matrix

Figure 2 describes the emission of three consecutive photons from an absolutely moving source. These photons are wave packets in different groups of neighboring E-Strings. They travel coherently and transversely towards the target. When a wave packet

hits the target it will have the effect of a particle hitting the target. This explains why light appears to have the duality properties of a particle and a wave packet. This picture of photon emission from a source implies that a detector in the same frame will not be able to detect all

the photons generated by the source. The reason is that by the time the first photon arrives at the original position of the detector it will have moved to a new location. In the section "The Consequences of Model Mechanics," I have demonstrated that such a motion of a detector in combination with the Pythagorean theorem gives rise to the Lorentz Factor (γ). This explains why all the processes of nature are Lorentz Invariant. Also, this explains why the Lorentz Factor appears in all the transform equations.

5. New Experiments to Detect Absolute Motion

The new interpretations of the past experiments support the concept of absolute motion. However, it would be more convincing if we can come up with new experiments that are specifically designed to detect

absolute motion. The following one-way experiments are proposed for this purpose:

Proposed Experiment #1

This proposed experiment is exactly the same as the Compton Effect Experiment (Figure 3) except that the x-ray is not a continuous beam. It is chopped into pulses and a clock at the source location determines the pulse rate. A wavelength detector and a pulse rate detector are placed in the detector's location. The Model Mechanical predictions of this proposed experiment are listed below. If these predictions are confirmed, it will have confirmed the existence of absolute motion and indirectly it will have confirmed the existence of the E-Matrix.

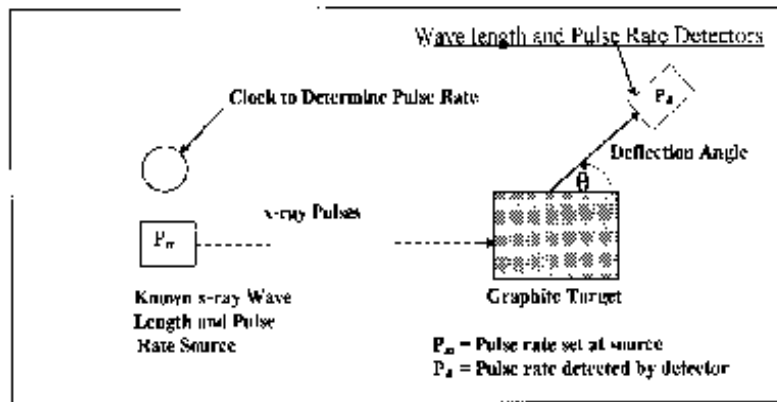

Figure 3. Experimental set-up for Proposed Experiment #1. This is a modified Compton Effect Experiment. It is designed to show that the red shifted peak is caused by the receding motion of the graphite target.

Expected Results

1. There will be two peaks detected at any deflection angle. The peak that has a wavelength the same as the incident x-ray is due to the absorption and re-emission of the incident x-ray. The receding absolute motion of the graphite target in the transverse direction causes the peak that has the wavelength that is red-shifted.
2. The peak that has the same wavelength as the incident x-ray will detect the same pulse rate as the incident x-ray. The peak that the wavelength is red-shifted will detect a pulse rate that is less than that of the incident x-ray. This specific prediction is in conflict with current physics that predicts that the detected pulse rate to be the same as the incident x-ray.
3. At any specific deflection angle, the pulse rate detected with the red-shifted x-ray will be less than that of the source rate. The greater is the scattering angle; the lower is the detected pulse rate. However, there is a maximum difference

between the source pulse rate and the detected pulse rate. This is confirmed with the Compton Effect experiment that was found to have a maximum red shift of 2.43×10^{-12} m or 2.43 pm. The lower pulse rate detected at the various scattering angles is due to the receding absolute motion of the graphite target. This receding motion is in the transverse direction relative to the incident x-ray. The maximum pulse rate difference will be detected at the scattering angle of 180° from the incident x-ray. This pulse rate difference is caused by the full value of the absolute motion of the graphite target. This prediction is in conflict with current physics that predicts that the detected pulse rate at all scattering angles is equal to the pulse rate at the source.

4. The STR Predictions for this experiment:

$$P_d = P_m (2.16)$$

The Model Mechanical predictions for this proposed experiment:

$$P_d = P_m \sqrt{1 - \frac{v^2 \cos^2 \theta}{c^2}} \quad (2.17)$$

- After the values of P_m and P_d are determined experimentally, the absolute motion (V) of the graphite target can be calculated using the following equation:

$$v \cos \theta = c \sqrt{1 - \frac{P_d^2}{P_m^2}} \quad (2.18)$$

Since the original Compton Effect experiment had confirmed that one of the peaks is red shifted this will guarantee that this modified Compton experiment will get the same result. In other words, the detected pulse rate will be less than the emitted pulse rate and the difference in rates is due to the state of absolute motion of the graphite target.

Proposed Experiment #2:

This proposed experiment is based on the Model Mechanical description of space and time. It is based on the assumption that all objects in the observer's frame are in a state of absolute motion and that this motion is detectable by this proposed experiment. The detection of absolute motion would refute the claims of Special Theory of Relativity (STR). Specifically it would refute the claim that all inertial frames of reference are equivalent and that no single frame is preferred. Also it would refute the claim that even if a preferred aether frame exists it is redundant and not detectable experimentally.

The step-by-step procedure for this proposed experiment is as follows:

- Two sets of cesium clocks A1, A2 and B1, B2 are located at the A location on one end of a 100 meter long rigid rod. The 100-meter distance is pre-determined using Einstein's procedure for measuring distance.
- Clocks A1 and B1 are not running and clocks A2 and B2 are running and are synchronized.
- Clocks B1 and B2 are slowly transported to the other end of the rod (B's location).
- A laser light source is at A's location and it emits a continuous light beam and a light pulse beam. It is equipped with a shutter. The opening and closing of the shutter will allow the continuous beam to activate and de-activates the clocks A1 and B1. The detection areas for the light beams at A1 and B1 are exactly 4 mm in diameter.
- Clock A1 is activated and de-activated by the continuous beam for exactly one second and identifies this value as T_a . The number of

pulses detected during this period is recorded and identifies this value as N_a . Clock B1 is activated and de-activated by the continuous beam and identifies this elapsed time as T_b . The number of pulses detected B1 during this period is recorded and identifies this value as N_b .

- Repeat steps 1 through 5 at different times of the day.
- Rotate the assembly to a different direction and repeat steps 1 to 6. This is designed to illustrate that the speed of light is the same in all directions.
- After all the experiments are completed, slow transport the B clocks (B1 and B2) to back to the A location and compare clocks A2 and B2 to see if they are still synchronized.

The STR predictions for these proposed experiments are as follows:

$$T_a = T_b = 1 \text{ second}$$

$$N_a = N_b$$

Clocks A2 and B2 are still synchronized.

If the aether frame exists, then the predictions for these proposed experiments are as follows:

$$T_a = 1 \text{ second and } T_b < 1 \text{ second}$$

$$N_a > N_b$$

Clocks A2 and B2 are still synchronized.

The relationship between T_a and T_b is as follows:

$$T_b = T_a \sqrt{1 - \frac{V^2}{c^2}} \quad (2.19)$$

Where V is the absolute motion of clock B1. After the value of T_b is determined, the absolute motion of clock B1 can be calculated as follows:

$$V = c \sqrt{1 - \frac{T_b^2}{T_a^2}} \quad (2.20)$$

The relationship between N_a and N_b is as follows:

$$N_b = N_a \sqrt{1 - \frac{V^2}{c^2}} \quad (2.21)$$

Where V is the absolute motion of clock B1. After the value of N_b is determined, the absolute motion of clock B1 can be calculated as follows:

$$V = c \sqrt{1 - \frac{N_b^2}{N_a^2}} \quad (2.24)$$

The theory behind these aether frame predictions is as follows:

- The light beams are traveling horizontally while the clock B1 is moving vertically. This situation is analogous to the familiar light

clock thought experiment which gives rise to the all important γ Factor in all the STR equations.

2. The absolute motion of clock B1 will cause the first batch of light pulses to miss the pulse counter. Similarly, it will cause the leading portion of the continuous beam to miss the detection area and thus delaying the activation of the clock B1. This delay in the activation of B1 is known time dilation..
3. The number of pulses missing the pulse counter and the time delay of activation is dependent on the state of absolute motion of clock B1. The higher is the state of absolute motion the more pulses will miss the pulse counter. Similarly, it will cause a longer time delay on the activation of the clock B1. At the speed of light all the pulses will miss the pulse counter and no portion of the continuous beam will reach the detection area in time to activate the clock. This situation is known as that time stands still at the speed of light.

6. Conclusions

The unique structure of the E-Matrix and the absolute motion of objects in it enable us to explain the weird results of three past famous experiments. Two new experiments that are capable of detecting the

motion of the observer in the E-Matrix frame are included. The detection of the E-Matrix frame will give us a new way to do physics. Also it will lead us to a viable unify theory for all the forces. Ref.[1].

Correspondence to:

Ken H. Seto
KHS Publishing
260 Yorkshire Lane
Xenia, OH 45385, USA
Telephone: 937-372-5298
Email: kenseto@erinet.com
<http://www.erinet.com/kenseto/book.html>

References

1. Seto K.H. Unification of Physics. http://www.geocities.com/kn_seto/2005Unification.pdf.
2. Seto KH, BS Chem. Engineer, 1962 Queen's University. Patentee: Two patents in the field of polymeric applications. Published papers in the field of fundamental physics. Author of two books: Model Mechanics: A New Interpretation of Nature; The Physics of Absolute Motion. Industrial experiences: Product Manager in the polymeric application field and consultant in the adhesive and sealant field.
3. Seto KH, The Physics of Absolute Motion, ISBN 0-9647136-1-6, KHS Publishing, pp 13-16; pp.110-126.
4. Seto KH. The Physics of Absolute Motion. ISBN0-9647136-1-6, KHS Publishing, pp 57-70, <http://www.erinet.com/kenseto/book.html>.
5. Seto KH. Unification of Physics. Journal of the Theoretics. pp 5-11, <http://www.journaloftheoretics.com/Links/Papers/Seto.pdf>.

A Theoretical Approach to the Overall Control of the Nervous System in Human Beings

Sum-Wah Lam

Russian Military Medical Academy, drswlam@gmail.com

Abstract: The First Law of the Overall Control of the Nervous System in Human Beings (The Law of Health and Disease): The shape and arrangement of our cerebral cortex controls our physiology as well as psychology. The Second Law of the Overall Control of the Nervous System in Human Beings (The Brain Functions Controlled Law): Postures as a habit can control the shape and arrangement of our cerebral cortex, which would in turn control our physiology and our psychology. The Third Law of the Overall Control of the Nervous System in Human Beings (The Hormonal Secretions Controlled Law): Whenever there is a change in the shape and arrangement of our cerebral cortex, there will be a change in the quantity of different major and orphan hormones, especially to those hormones which have direct or indirect relationship with the pituitary gland and the hypothalamus. [Nature and Science. 2006;4(2):11-17].

Keyword: Overall Control; Nervous System; Human Beings

Contents:

- (A) Introduction
 - (B) The First Law of the Overall Control of the Nervous System in Human Beings (The Law of Health and Disease): The shape and arrangement of our cerebral cortex controls our physiology as well as psychology.
 - (C) The Second Law of the Overall Control of the Nervous System in Human Beings (The Brain Functions Controlled Law): Postures as a habit can control the shape and arrangement of our cerebral cortex, which would in turn control our physiology and our psychology.
 - (D) The Third Law of the Overall Control of the Nervous System in Human Beings (The Hormonal Secretions Controlled Law): Whenever there is a change in the shape and arrangement of our cerebral cortex, there will be a change in the quantity of different major and orphan hormones, especially to those hormones which have direct or indirect relationship with the pituitary gland and the hypothalamus.
 - (E) Discussion
 - (F) The Inter-relationship between the three laws
- References

(A) Introduction

The term “Nervous disorder” implies that someone is suffering from psychiatric sickness, which results in both physiological and psychological changes. In other words, all these physiological and psychological changes are originated in part or in

whole from the change in the shape and arrangement of one’s cerebral cortex and its associated organs. This has an enormous implication to health and disease. Three laws are proposed by the author to portray how we can control the shape and arrangement of our cerebral cortex and its associated organs. Law 1 states that the shape and arrangement of our cerebral cortex and its associated organs control our physiology as well as our psychology. Law 2 states that postures as a habit can maintain or change the shape and arrangement of our cerebral cortex and its associated organs. Law 3 states that whenever there is a change in the shape and arrangement of our cerebral cortex and its associated organs, there is always a change in the quantity of different major and orphan hormones secreted. These three laws are proposed by the author to be the Laws of the Overall Control of the Nervous System in Human Beings. Below are the theoretical frameworks of these three laws.

(B) The First Law of the Overall Control of the Nervous System in Human Beings (Law of Health and Disease): The shape and arrangement of our cerebral cortex and its associated organs control our physiology as well as our psychology. Below are some of the facts, which support the first law:

Systematic changes (asymmetrical in nature) in hemispheric organization are associated with pathological disturbances of mood (Flor-Henry, 1983). Deglin and Nikolaenko (1975) found that at the end of laterised induced seizure, sensori-motor

cortical functions are transiently depressed. Laterization to the dominant hemisphere was produced profound intellectual retardation while laterization to non-dominant hemisphere lead to distinct intensification of emotional manifestations. Golden et al (1980) found that CT scan showed that the density of left hemisphere was greater than that of the right for a number of chronic schizophrenics. Sowell ER, Levitt J, Thompson P.M., Holmes CJ, et al. (2000) found brain abnormalities in MRI in mapping of the cerebral cortex and its associated organs). Niemann K., Hammers A., Coenen VA, Thron A., and Klosterkötter J. (2000) demonstrated that a smaller left hippocampus and left temporal horn in schizophrenic patients. Gur RE, Turetsky BI, Cowell PE, Finkelman C., Maany V., et al., (2000) found ventricular enlargement in schizophrenics. Crespo-Facorro B., Kim J., Andreasen NC, O'Leary DS, and Magnotta V (2000) showed there were regional frontal abnormalities in schizophrenia patients. Flashman LA, McAllister TW, Andreasen NC, and Saykin AJ (2000) found there was a smaller brain size associated with schizophrenics. Garver DL, Nair TR, Christensen JD, Holcomb JA, and Kingsbury, SJ (2000) demonstrated that there was instability in brain and ventricle for psychotic patients. Hirayasu Y, Shenton ME, Salisbury DF, and McCarley RW (2000) conducted a study on the hippocampal and superior temporal gyrus volume on schizophrenics and found they are different from normal subjects. Sanfilippo M, Lafargue T., Rusinek H, Arena L, Loneragan C, Lautin A, Lautin A, and Feiner D, et.al. (2000) found there were volumetric differences in the measurement of the frontal and temporal lobe regions in schizophrenics. Downhill JE, Buchsbaum MS, Wei T, Spiegel-Cohen J., Hazlett EA, Haznedar MM, Silverman J, and Siever LJ, (2000) showed that there were difference in the shape and size of the corpus callosum in schizophrenics. These are some of the findings on the relationship between the shape and arrangement of the cerebral cortex and its associated organs, and schizophrenics. Findings on the relationship between the shape and arrangement of patients with anxiety, mania, sexual disorder, and other psychopathology are many. In fact, Sowell ER, Toga AW, and Asarnow R (2000) did a literature review on the abnormalities in shape and arrangement of the cerebral cortex and its associated organs as demonstrated by magnetic resonance images.

All these demonstrate that the cause of physiological and psychological disorders is rooted in the change in shape and arrangement of the cerebral cortex and its associated organs. Therefore, if we

can control the shape and arrangement of different parts of the cerebral cortex and its associated organs, we can control our physiology as well as our psychology.

(C) The Second Law of the Overall Control of the Nervous System Human Beings (The Brain Functions Controlled Law): Postures as a habit, through tension and relaxation of our voluntary muscles, can maintain or change the shape and arrangement of our cerebral cortex, which would mean postures as a habit, can control our physiology as well as our psychology (Our voluntary muscular system controls the shape and arrangement of our cerebral cortex). Below are some of the facts, which support the second law:

1. Theories on therapeutic exercise contain much information on the relationship between exercise and therapy on certain diseases. As a result, exercise prescription is possible (Oshida Y, 2000; Kimura Y, and Iwasaka T, 2000; Sunami Y, Kiyonaga A, and Tanaka H, 2000; van der Velde G, and Mierau D, 2000; Phillips B.A., and Mastaglia FL, 2000; Kimura Y, 2000; Babyak M, Blumenthal J.A., Herman S, et.al., 2000; van Tulder M, Malmivaara A., Esmail R., and Koes B, 2000). During the process of exercise therapy, certain muscles are relaxed or at tension repeatedly. Therapy is possible because the voluntary muscular system controls the shape and arrangement of the cerebral cortex and hence can control the functions of the nervous system.

2. Yoga exercise is a well-established discipline, which has a very long history. Practitioners of the Yoga Exercise can maintain both their mind and body healthy, through certain postures as a habit. For many people with physiological or psychological defects, Yoga exercise provides a means of therapy (Kamei T, Toriumi Y, Ohno S, et.al, 2000; Tooley G.A, Armstrong SM, Norman TR, and Sali A, 2000; Bera TK, Gore MM, and Oak JP, 1998; Raghuraj P, Ramakrishnan AG, Nagendra HR, and Telles S, 1998; Murugesan R, Govindarajulu N, and Bera TK, 2000; Ramaratam S, and Sridharan K, 2000; Hudson S, 1998; Farrell SJ, Ross AD, and Sehgal KV, 1999; Gotter AC, 1999; and Singh R, 1999). This is possible because Yoga exercise can change the shape and arrangement of one's cerebral cortex and hence can change one's physiology and psychology, which can be used as a means of therapy.

3. Dunkell's Theory (1977) on sleep postures as a habit has portrayed that there is a closed relationship between sleep postures and personality. This is only possible if a particular type

of sleep posture will lead to a particular kind of shape and arrangement of one's cerebral cortex.

It is recorded in ancient Chinese sex books that different postures as a habit in the process of sexual intercourse provide means of therapy to certain diseases. People who practice such postures can become healthier (Wilson G, 1989; and, Stanway A, 1988).

4. It is known that the body language, the postures of sitting and walking, reflects our psychology and physiology (Pell AR, 1989; Leiber B, 1992; Kurz C, 1981; Russell RL and Stiles WB, 1979; Babic R, Green E, Bessineton JC, and Baron JB, 1978; Bijeliac-Babic R., 1978; Lundgren BF, 1994). It is also known that improper postures will result in chronic disease, for example, low back pain (Hartvigsen J, Leboeuf-Yde C, Lings S, and Corder EH, 2002; Clark AJ, 1996; Kauppila LI, 1996; Chilvers CD, Parker AH, and Guillen G, 1996). The above phenomena can be explained by saying that our postures are controlled by the shape and arrangement of our cerebral cortex and the voluntary muscular system controls the shape and arrangement of our cerebral cortex.

5. Alexander Technique also provides means of therapy to certain diseases by having certain postures as a habit. This involves particular types of posture, which is only possible if the voluntary muscles control the shape and arrangement of the cerebral cortex and hence can change the physiology and psychology of the practitioner (Gelb M, 1981; Huxley, 1940; Huxley, 1986; Jeffers, S, 1988; Barlow W, 1984; Maisel E, 1974; Lewis D, 1986; Alexander F.M., 1987; and Hayne, CR, 1987).

(D) The third law of the Overall Control of the Nervous System in Human Beings (The Hormonal Secretions Controlled Law): Whenever there is a change in posture as a habit, which involves voluntary muscles, there is always associated with a change in the quantity of endocrine secretions, especially to those hormones which have direct or indirect relationship with the pituitary gland and the hypothalamus. Below are some of the facts:

Postures as a habit during different physical activities and rest can alter the quantity of hormonal secretions (Brooke-Wavell K, Prelevic GM, Bakridan C, and Ginsburg J, 2001; McMahan M and Palmer RM, 1985; Moreau KL, Degarmo R, Langley J, et.al., 2001; Wheeler GD, Wall SR, Belcastro AN, and Cumming DC, 1984; Heitkamp HC, Huber W, and Scheib K, 1996; Bunt JC, Boileau RA, Bahr JM, and Nelson RA, 1986; Cumming DC, Brunsting LA 3rd, Strich G, Ries AL, and Rebar RW, 1986; Mathur DN,

Toriola AL, and Dada OA, 1986; Ronkainen HR, Pakarinen AJ, Kauppila AJ, 1986; Houmard JA, Costill DL, Mitchell JB, Park SH, Fink WJ, and burns JM, 1990; Mathur RS, Neff MR, Landgrebe SC, et.al., 1986), to quote a few.

(E) Discussion

1. How our physiology and psychology are controlled?

CT and MRI scan films show that many serious psychiatric sicknesses show peculiar patterns of shape and arrangement with the cerebral cortex and its associated organs. These indicate that the shape and arrangement of our cerebral cortex and its associated organs are relevant to our physiology as well as psychology. In fact, numerous diseases, which etiologies are unknown at present, for example, all types of hormonal diseases, such as diabetes mellitus, thyrotoxicosis, various kinds of cancer, and many other benign and malign diseases are originated from having problems with the shape and arrangement of our cerebral cortex and its associated organs. The mechanism in controlling one's disease and well-being is that when the geometric shape of some convolutions in the cerebral cortex change, there are always a change in the degree of one's physiological and psychological variables. By this mechanism, physiological and psychological variables can shift from one extreme to another. This explains how homeostasis can be disturbed and maintained, i.e. depending on the shape and arrangement of one's cerebral cortex and its associated organs. The first law of the Overall Control of the Nervous System in Human Beings explains the causes of numerous diseases which have no answers at the moment, such as various kinds of cancer, various kinds of heart diseases, schizophrenia and other psychiatric sicknesses, which the diseases causes are unknown. All human physiology and psychology are controlled by the shape and arrangement of their cerebral cortex and its associated organs.

2. How to control the shape and arrangement of our cerebral cortex, so as to control our physiology as well as our psychology?

If the author's first postulate is right, how to control the shape and arrangement of the human cerebral cortex will come next so as to solve physiological and psychological problems. If we can control the shape and arrangement of our cerebral cortex and its associated organs, we can control most aspects of our physiology and psychology. Law two of the Overall Control of the Nervous System in

Human Beings portrays how our physiology and psychology can be controlled. In fact, the shape and arrangement of our cerebral cortex and its associated organs are controlled by our voluntary muscular system, i.e. by having postures as a habit. In fact, our ancestors have developed many methods to control the shape and arrangement of our cerebral cortex, though they did not know why they work and could not explain them on scientific grounds, such as postures as a habit in exercise, sleep, sexual intercourse, sitting, walking, or any kind of sports or device which voluntary muscular movements or postures as a habit are involved. In fact, all known cases of malign and benign diseases that can be cured without having any known medical treatment must have some changes in the shape and arrangement of his or her cerebral cortex and its associated organs to make him or her healthy again by chance or by accident. These cases are not miracles. In addition, by analyzing one's different postures it is possible to know his/her physiology or psychology, which is useful in diagnosis or prognosis of certain physical and mental diseases. Furthermore, it is possible to tell one's physiology and psychology at different times by analyzing his/her handwriting at different stages of his/her life. The author also found that musculature on our face, the shape of the eye brows and the lines on our hands change as a result of changing in habits of certain postures in different times of our life which reflect a change in our psychology and physiology.

There are many ways to prove that our voluntary muscular system controls functions of the brain. One of the immediate consequence is that decussation of nerve fibers in the brain stem can be interpreted. It usually needs a signal from the cerebral cortex to execute a voluntary movement. It is also known that the left-brain controls the right side of the muscular system, and vice versa. In fact, when a signal is executed from the left-brain for a voluntary movement on the right side, the muscles on the right side will exert a signal to the right brain so as to set a balance on the left side of the muscular system. The reverse is also true, which is essential in maintaining homeostasis. This can be easily proved in a laboratory where facilities for measurement of electrical activities are available.

It is recorded clinically that many diseases, including the communicable diseases, tuberculosis, and the non-communicable diseases, various kinds of cancer, can be cured without the intake of medicine or having other known medical treatments. Scientists should not believe in miracles. The mechanism on these is simple, as there must be some

changes on the shape and arrangement of the patients' cerebral cortex for them to get recovered. In fact, numerous malignant and benign diseases are given arisen because there were changes in the shape and arrangement of the cerebral cortex. It is also under the same mechanism which people with malignant and benign diseases can be cured without having medical treatments.

Laws of the Overall Control of the Nervous System explain the etiology of many non-communicable diseases and some communicable diseases. They explain how many psychiatric sicknesses are given rise, including epilepsy, schizophrenia, affective disorder, hysteria, obsessional states, and finally sexual disorder. They explain how we can get cured in many sicknesses without the intake of medicine and receiving any known medical treatment. They also explain how physiological brain-washing is possible. By the application of these hypotheses mental giants such as Einstein and other great thinkers can be produced in a sleep laboratory.

Dunkell (1977) found that people with different sleep postures have different personality. But how about if we ask people to change their sleeping positions as a habit? Shall we expect a change in his/her personality as well? I believe and support the statement that there will be a change in personality from the first type to the second type. If not, all information from Dunkell's book will be invalid. Therefore, sleep postures as a habit can portray one's tendency for different diseases. Buddha did sleep in some particular position as a habit, and he was also famous for his ability to control his physiology and psychology. I believe that Buddha was the first person, who knew some of the ways to control human physiology and psychology, by sleeping or sitting in some particular positions. My Laws can link up the gap between oriental and western medicine. I believe that Buddhism is a treasure source of information on how to control human physiology and psychology through different postures.

Therefore, if we can control the shape and arrangement of one's cerebral cortex, we can control his or her sicknesses. Unfortunately, no controlled experiment on this has been done and the author thinks a study on the relationship between shape and arrangement of the cerebral cortex and its associated organs, and psychopathological variables is necessary.

In the coming few decades, scientists can devise means to alter or change patient's shape and arrangement of their cerebral cortex and its

associated organs by means of electrical methods, such as the Electro-convulsive Therapy, Yoga exercise, breathing exercise, chemical convulsants, or any voluntary movement which muscles are involved, so as to cure diseases. This is very important in the treatment of all kinds of sickness symptoms, no matter physical or psychological, mild or serious.

3. Effects on change in the shape and arrangement of our cerebral cortex on the quantity of hormonal secretions

When there are changes in postures as habit, such as having a particular kind of sports, exercise, there are always changes in quantity of different hormonal secretions, as demonstrated by Law Three of the Overall Control of the Nervous System in Human Beings. One of the very factors how Yoga exercise is effective in controlling our physiology as well as our psychology is that Yoga exercise has profound influence on the quantity of different hormonal secretions. The shape of our skull is another factor, which can determine our physiology and psychology, as the shape and arrangement of our cerebral cortex always depends on the shape of our skull. As far as to healing diseases are concerned, we certainly can control our postures as a habit to deal with the benign and malignant diseases.

(F) Inter-relationship between the three laws:

The shape and arrangement of our cerebral cortex control our physiology and psychology (Law 1) and the shape and arrangement of our cerebral cortex in turn is controlled by our postures as a habit (Law 2). Postures as a habit controls our physiology and psychology, this is possible because the shape and arrangement of our cerebral cortex controls the secretions, in terms of quantity, of different major and orphan hormones (Law three).

Correspondence to:

Sum-Wah Lam

P.O. Box 806, Tuen Mun Central Post Office,

Hong Kong SAR, China

Telephone: (+852) 8119 8135; Fax: (+852) 3014 5724

E-mail: drswlam@gmail.com

References:

1. Aaronson, S.T., Siham, R., Biber, M.P and Hobson, J.A. (1982) Brain state and body position. Arch. Gen. Psychiatry, 1982, 39, 330-5.
2. Alexander FM (1932). The use of self. Dutton, New York.
3. Babic R, Green E, Bessineton JC, and Baron JB (1978).

- Body language and tonic postural action. Agressologie. 1978; 19(B): 51-2.
4. Barrow, W. (1984). The Alexander Principle. Arrow.
5. Bera TK, Gore MM, and Oak JP (1998). Recovery from stress in two different postures and in Shavasana-a yogic relaxation posture. Indian J Physiol Pharmacol. 1998;42(4): 473-8.
6. Berbard, T. Hatha Yoga. London: Rider, 1968
7. Bijeljic-Babic R. (1978). Body language and communication. Agressologie. 1978; 19(6):349-51.
8. Brooke-Wavell K, Prelevic GM, Bakridan C, and Ginsburg J. (2001). Effects of physical activity and menopausal hormone replacement therapy on postural stability in postmenopausal women-a cross sectional study. Maturitas 2001 Jan 31; 37(3):167-72.
9. Bunt JC, Boileau RA, Bahr JM, and Nelson RA. (1986). Sex and training differences in human growth hormone levels during prolonged exercise. J App Physiol 1986 Nov; 61(5): 1796-801.
10. Cartwright, R.D. Effect of sleep position on sleep apnea severity. Sleep. New York, Raven Press, 1984.
11. Chilvers CD, Parker AH, and Guillen G (1996). Low back pain. NZ Med J. 1996 Aug 23; 109(1028):324.
12. Clark AJ (1996). Back pain without apparent cause. CMAJ. 1996 Oct 1; 155(7):861-2.
13. Crespo-Facorro B, Kim J, Andreasen NC, O'Leary DS, and Magnotta V. (2000). Regional frontal abnormalities in schizophrenia: a quantitative gray matter vs. and cortical surface size study. Biol Psychiatry. 2000. July 15; 48(2):110-9.
14. Cumming DC, Brunsting LA 3rd, Strich G, Ries AL, and Rebar RW. (1986). Reproductive hormone increases in response to acute exercise in men. Med Sci Sports Exerc 1986 Aug; 18(4): 369-73.
15. Deglin V.L., Nikolaenko N.N. (1975) Role of the dominant hemisphere in the regulation of emotion states. Human Physiology. 1975: 1(3).
16. De Koninck J., Gagnon P., and Lallier. Sleep positions in the young adult and their relationship with subjective quality of sleep. Sleep. New York, Raven Press, 1983.
17. Domino G and Bohn S.A. Hynagogic exploration: Sleep positions and personality. J. Clin. Psychol. 1980;36:760-2.
18. Downhill JE, Buchsbaum MS, Wei T, Spiegel-Cohen J, Hazlett EA, Haznedar MM, Silverman J, and Siever IJ. (2000). Shape and size of the corpus callosum in schizophrenia and schizotypal personality disorder. Schizophr Res. 2000 May 5, 42(30): 193-208.
19. Dunkell, S., Sleep positions. New York, William Morrow, 1977.
20. Farrell SJ, Ross AD, and Sehgal KV (1999). Eastern movement therapies. Phys Med Rehabil. Clin N Am. 1999 Aug; 10(3): 617-29.
21. Felson, B. Computerized Cranial Tomography. New York: Grune and Stratton, 1977.

22. Flashman LA, McAllister TW, Andreasen NC, and Saykin AJ. (2000). Smaller brain size associated with unawareness of illness in patients with schizophrenia. *Am J Psychiatry*. 2000 Jul; 157(7): 1167-9.
23. Flor_Henry, Pierre. *Cerebral basis of psychopathology*. Bristol: John Wright. (1983).
24. Gelb, M (1981). *Body learning: An introduction to the Alexander Technique*. Aurum Press, 1981.
25. Golden, C.J., Graber B., Coffman J. et al (1980) Brain density deficits in chronic schizophrenia. *Psychiatry Res*. 1980.
26. Gotter AC (1999). Western movement therapies. *Phys Med Rehabil Clin N Am*. 1999 Aug; 10(3): 603-16.
27. Gur RRe, Turetsky Bi, Cowell PE, Finkelman C, Maany V, Grossman RI, Arnold SE, Bilker WB, and Gur RC. (2000). Temporolimbic volume reductions in schizophrenia. *Arch Gen Psychiatry*. 2000 Aug; 57(8): 769-75.
28. Hartvigsen J, Leboeuf-Yde C, Lings S, and Corder EH (2002). Does sitting at work cause low back pain? *Ugeskr Laeger*, 2002 Feb 4; 164(6): 759-61.
29. Hayne C.R. (1987). *Total back care*. Dent.
30. Heithkamp HC, Huber W, and Scheib K. (1996). Beta-Endorphin and adrenocorticotrophin after incremental exercise and marathon running-female responses. *Eur J App Physiol Occup Physiol* 1996; 72(5-6): 417-24.
31. Hewitt, J. *Teach yourself Yoga*. London: English University Press, 1960.
32. Hirayasu Y, Shenton ME, Salisbury DF, and McCarley RW. (2000). Hippocampal and superior temporal gyrus volume in first-episode schizophrenia. *Arch Gen Psychiatry*. 2000 Jun; 57(6): 618-9.
33. Hobson, J.A., Spagna, T. & Malenka, R. Ethology of sleep with time-lapse photograph: Postural immobility and sleep cycle phase in man. *Science*, 1978, 201, 1251-3.
34. Houmard JA, Costill DL, Mitchell JB, Park SH, Fink WJ, and Burns JM (1990). Testosterone, cortisol, and creatine kinase levels in male distance runners during reduced training. *Int J Sports Med* 1990 Feb; 11(1):41-5.
35. Hudson S. (1998). Yoga aids in back pain. *Aust Nurs J* 1998 Apr; 5(9):27.
36. Huxley, A. (1940). *Ends and means*. Chatto and Windus
37. Huxley, A. (1986). *Eyeless in Gaza*. Grafton.
38. Jeffers, S. (1988). *Feel the fear and do it anyway*. Century.
39. Kamei T, Toriumi Y, Kimura H., et.al. (2000). Decrease in serum cortisol during Yoga exercise is correlated with alpha wave activation. *Percept Mot Skills*. 2000 Jun; 90(3 pt 1): 1027-32.
40. Kauppila LI. Studying low back pain. *Spine*. 1996 Feb 15; 21(4):527.
41. Kimura, Y. (2000). Exercise therapy for hypertension. *Nippon Rinsho*. 2000 Feb; 58 Suppl 2:56-9.
42. Kimura Y, and Iwasaka T. (2000). Complication of exercise therapy. *Nippon Rinsho*. 2000 Sep.58 Suppl: 226-8.
43. Kurokawa K, Nakamura K., Sumiyoshi T, Hagino H, Yotsutsuji T, Yamashita I., Suzuki M., Matsui M, and Kurachi M. (2000) Ventricular enlargement in schizophrenia spectrum patients with prodromal symptoms of obsessive-compulsive disorder. *Psychiatry Res*. 2000 Aug 28; 99(2):83-91.
44. Kurz C. (1981). Language and behaviour, two means of communication. *Soins Psychiatr*. 1981 Oct; (12):2.
45. Leiber, B. (1992). Body language: "Language to be seen". *Kinderkrankenschwester*, 1992 Mar; 11(3):94-5.
46. Lewis, D. (1986). *The Alpha Plan*. Methuen.
47. Lundgren BF (1994). Your body language reveals you! *Vardfacket*. 1994 June 2; 18(10):4-6.
48. Maisel E. (1974). *The Alexander Technique: Essential writings of F.M. Alexander*. Thames and Hudson.
49. Mathur DN, Toriola AL, and Dada OA (1986). Serum cortisol and testosterone levels in conditioned male distance runners and non-athletes after maximal exercise. *J Sports Med Phys Fitness* 1986 Sep; 26(3): 245-50.
50. Mathur RS, Neff MR, Landgrebe SC, Moody LO, Kirk RF, Gadsden RH Sr, and Rust PF. (1986). Time-related changes in the plasma concentrations of prolactin, gonadotropins, sex hormone-binding globulin, and certain steroid hormones in female runner after a long-distance race. *Fertil Steril* 1986 Dec; 46(6): 1067-70.
51. McMahon M and Palmer RM (1985). Exercise and hypertension. *Med Clin North Am* 1985 Jan; 69(1):57-70.
52. Moreau KL, Degarmo R, Langley J, McMahon C, Howley ET, Bassett DR, and Thompson DL (2001). Increasing daily walking lowers blood pressure in postmenopausal women. *Med Sci Sports Exerc* 2001 Nov; 33(11): 1825-31.
53. Murugesan R, Govindarajulu N., and Bera T.K. (2000). Effect of selected yogic practices on the management of hypertension. *Indian J Physiol Pharmacol* 2000 Apr; 44(2): 207-10.
54. Niemann K, Hammers A, Coenen VA, Thron A., and Klosterkotter J. (2000). Evidence of a smaller left hippocampus and left temporal horn in both patier first episode schizophrenias and normal control subjects. *Psychiatry Res*. 2000 Aug 28; 99(2): 93-110.
55. Oshida, Y. (2000). Practice of exercise therapy for diabetes mellitus. *Nippon Rinsho*. 2000 Sep; 58 Suppl: 391-6.
56. Pell AR (1989). Body language. *Indiana Med*. 1989 Sep; 82(9):749.
57. Phillips BA, and Mastaglia FL (2000). Exercise therapy in patients with myopathy.
58. Raghuraj P, Ramakrishnan AG, Nagendra HR, and Telles S. (1998). Effect of two selected yogic breathing techniques of heart rate variability. *Indian J. Physiol Pharmacol*. 1998 Oct; 42(4): 467-72.
59. Ramaratnam S, and Sridharan K. (2000). Yoga for epilepsy. *Cochrane Database Syst Rev*. 2000; (2): CD001524. Review.
60. Ronkainen HR, Pakarinen AJ, and Kauppila AJ (1986). Adrenocortical function of female endurance runners and joggers. *Med Sci Sports Exerc* 1986 Aug; 18(4):385-9.
61. Russell RL and Stile WB. (1979). Categories for classifying

- language in psychotherapy. *Psychol Bull.* 1979 Mar; 86(2):404-19.
62. Singh R. (1999). Role of yogic exercises/meditation in aircrew stress management. *Aviat Space Environ Med.* 1999 Sep; 70(9):939.
63. Sivananda, S. *Practice of Yoga.* Sivanandanagar, U.P. Ddivine Life Society, 1970.
64. Sodee, D.B. *Correlations in diagnostic imaging.* New York: Appleton Century Crofts, 1979.
65. Solis, H., Fernandez-Guardiala & Valverde, R. in "Neuropharmacologic and Neuroendocrine inter-relations of Human Sleep" in the *Function of Sleep*, New York: Academic Press, 1979.
66. Sowell ER, Toga AW, and Asarnow R. (2000). Brain abnormalities observed in childhood-onset schizophrenia: a review of structural magnetic resonance imaging literature. *Ment Retard Dev Disabil Res Rev.* 2000; 6(3):180-5. Review.
67. Sowell ER, Levitt J., Thompson PM, Holmes CJ, Blanton RE, Kornsand DS, Caplan R, McCracken J, Asarnow R, and Toga AW. Brain abnormalities in early-onset schizophrenia spectrum disorder observed statistical parametric mapping of structural magnetic resonance imaging of volume differences in brain structure. *Am J Psychiatry.* 2000 Sep; 157(9): 1475-84.
68. Stanway, A. (1988). *The loving touch.* Barcelona: Guild Publishing.
69. Sunami Y, Kiyonaga A, and Tanaka H. (2000). The basic concept of exercise therapy. *Nippon Rinsho.* 2000 sep; 58 suppl:216-20.
70. Thomson, John A. *An introduction to clinical endocrinology.* New York: Churchill Living Stone, 1976.
71. Tooley GA, Armstrong SM, Norman TR, and Sali A (2000). Acute increases in night-time plasma melatonin levels following a period of meditation. *Biol. Psychol.* 2000 May; 53(1):69-78.
72. Van de Velde G, and Mierau D. (2000). The effect of exercise on percentile rank aerobic capacity, pain, and self-rate disability in patients with chronic low-back pain: a retrospective chart view. *Arch Phys Med Rehabil.* 2000. Nov; 81(11):1457-63.
73. Vivekananda, S. *Raja Yoga, or conquering the internal nature.* Calcutta: Advavita Ashrama, 1950.
74. Wheeler GD, Wall SR, Belcastro AN, and Cumming DC (1984). Reduced serum testosterone and prolactin levels in male distance runners. *JAMA* 1984 Jul 27; 252(4):514-6.
75. Wilson G (1989). *The sensual touch.* London: Guild Publishing.

New Explorations to Hawking Radiation With Classical Theories

---- Part 4 of "New Concepts to Big Bang and Black Holes"^{[1][2]}----

Dongsheng Zhang

Graduated in 1957 From Beijing University of Aeronautics and Astronautics. China.

Permanent address: 17 Pontiac Road, West Hartford, CT 06117-2129, U. S. A.

Email: ZhangDS12@hotmail.com

Abstract: In part 1 and part 2 of "New Concepts to Big Bang and Black Holes"^{[1][2]} (abbreviation is NCBBBH), it had been pointed out that, "the Hawking theory about BH (**Black Hole**) extricates the crisis of pure GTR (General Theory of Relativity) about Singularity in BH^[2]", and "Just from Hawking theories of BHs, it has been known that BHs could always change its energy-matters with its surroundings^[2]". It has been a common knowledge that BHs can plunder energy-matters from outside with its very strong gravity, but almost nobody knows how to emit out Hawking radiation from BHs to outside. Normally, Hawking radiation may be formally explained with Uncertainty Principle of Quantum Mechanics, which recognized that a pair of virtual particles would be suddenly born out from vacuum, then annihilate and disappear at once^[3]. The abstruse problems of that explanation are: why the energy gotten from BH by a fled particle is just equal to the energy of another one captured by BH and exactly equal to the energy of a particle (i.e. Hawking radiation) on the instable Event Horizon of any BH, in addition, the existence of so-called "particles of negative energy" has not had any observational evidence yet, and so-called "virtual energy" has not had a reliable numerical value right now in any theory and experiment. In this article, through calculations to different BHs with laws of classical theories, the characteristics of Hawking radiation may be firstly and better explained and exposed by classical theories. The important contribution of this article is to have truly discovered the secret of BHs to emitting Hawking radiations, i.e. any Schwarzschild BH might almost simultaneously emit 6 Hawking radiations together to outside from two opposite directions of 3 dimensions of itself. [Nature and Science. 2006;4(2):18-22].

Key Words: Hawking radiation, characteristics of Hawking radiation, checks to Hawking radiation with classical theories.

Introduction

Why could BHs, from which even lights had no way to escape out, emit Hawking radiation? What are the characteristics of Hawking radiation?

In this article, the calculated fundamental principles and formulas all come out from NCBBBH^{[1][2]}, i.e. originate from classical theories (GTR, Hawking theory about BH and thermodynamics etc). Through further detailed calculations and qualitatively analyses to three following different real gravitational BHs already studied in NCBBBH, the characteristics of Hawking radiation may be more easily exposed and conceived with classical theories.

(i). BHs of ($m_t = 10^{-5}g$)^{[1][2]}: From part 1 of NCBBBH, it can be seen that, all BHs of ($m_t = 10^{-5}g$) were **minimum gravitational BHs (MGBH)**. They only appeared at the genesis of our universe and formed our present universe. They would be impossible to appear again in all lifetime of our universe.

(ii). BHs of ($m_{om} \approx 10^{15}g$)^[2]: In part 2 of NCBBBH, any BH of ($m_t = 10^{15}g$) is a mini BH and has only

existed in star-formed BH. **They are all middle-sized BHs.**

(iii). BH of ($M_u = 10^{56}g$)^{[1][2]}: In part 1 and 2 of NCBBBH, BH of ($M_u = 10^{56}g$) is a real **maximum BH**, which is just our present universe.

1. Formulas for calculating parameters of real gravitational black holes (RGBH)

Only Schwarzschild's BHs (no charges, no rotating and spherical symmetry) will be studied in this article below.

$$R_b = 2GM_b/C^2, \text{ or } C^2 = 2GM_b/R_b \quad [1][2] \quad (1a)$$

According to GTR, (1a) is the necessary condition for existence of any RGBH.

According to Hawking formulas about BH,

$$T_b = (C^3/4GM_b) \times (h/2\pi\kappa) \approx 0.4 \times 10^{-6} M_b / \approx 0.8 \times 10^{27} / M_b (k) \quad [4][1][2] \quad (1b)$$

$$\tau_b \approx 10^{-27} M_b^3 (s) \quad [4][1][2] \quad (1c)$$

Other formulas are cited below:

$$E_1 = m_p C^2, \quad E_2 = \kappa T, \quad E_3 = Ch/\lambda \quad (1d)$$

$$M_b = 4\pi\rho_b R_b^3/3 \quad (1e)$$

$$R_b = 3h/(2\pi C m_s) \quad [2] \quad (1f)$$

For any formed RGBH i.e. **Schwarzschild's BH**, its various parameters in above formulas are below: if M_b —mass of a formed RGBH, then, R_b —its Schwarzschild's radius, T_b —temperature on Event Horizon, ρ_b --density on Event Horizon, G --gravitational constant, κ -- Boltzmann's constant, h —Plank's constant, C —light speed, m_{sr} —mass of Hawking radiation emitted out from BH, m_s —mass of a particle in BH, τ_b —lifetime of a RGBH, E_1 —energy of mass m_p , E_2 –energy of a particle, E_3 – energy of a radiation, λ --wavelength of a radiation, ν --frequency of a radiation.

For convenient calculation, formula (1a) can be altered into:

$$M_b/R_b = C^2/2G \approx 0.675 \times 10^{28} \text{g/cm} \quad (1a)$$

2. The further analyses and modification to formula (1f) -- $R_b = 3h/(2\pi C m_s)$

Formula (1f) above comes from formula (13bd), which is derived in section (B) of paragraph 13 in part 2 of NCBBBH according to the balance between the central gravity of a BH and its heat pressure to a particle m_s at any point in a BH. **In this article, m_{sr} are only defined on or closely linked to Event Horizon (boundary) of any BH, ($m_{sr} = m_s$)** is just on Event Horizon, they may be conceived either in mass of a particle or in equivalent mass of radiation owing to the duality of waves and particles. In the process to derive formula (1f) in NCBBBH, m_s had been supposed to be a single particle. However, in reality, m_s might be the sum of ($m_s = n \times m_{sr}$) emitted out simultaneously as Hawking radiations from Event Horizon (boundary). m_{sr} —a radiation on Event Horizon,

$$\text{Suppose } m_s = n \times m_{sr}, \text{ and let } n = 6 \quad (2a)$$

From (1f) and (2a)

$$R_b m_{sr} = h/(4\pi C) \quad (2b)$$

Why would let $n = 6$? Let's look back to formulas (5e) and (5g) in paragraph 5 of part 1 of NCBBBH,

$$\text{From (5e), } m_p = (hC/8\pi G)^{1/2} = 10^{-5} \text{g}^{[6][1]}$$

$$\text{From (5g), } l_p = t_p \times C = (Gh/2\pi C^3)^{1/2} [6][1]$$

In (5g), t_p is Plank time, so, m_p is analogous to m_{sr} , and l_p is analogous to R_b .

$$\text{As a result, } m_p \times l_p = h/(4\pi C) \quad (2c)$$

Thus, (2b) \equiv (2c)

Therefore, it can be seen from formulas (1f) and (2b) or (2c), on Event Horizon of a BH, **a real m_{sr} is solely confined by R_b , i.e. M_b of a BH.**

$$M_b m_{sr} = hC/(8\pi G) = 1.187 \times 10^{-10} \text{gg} \quad (2d)$$

From (2d), in case M_b is a given value, m_{sr} on Event Horizon is thus gotten an exact value. Correspondingly, from formula (1d),

$$m_{sr} = \kappa T_b / C^2 = h/C\lambda_{sr} = h\nu_{sr}/C^2 \quad (2e)$$

(i). If $m_s > m_{sr}$, hence, $M_b m_s > 1.187 \times 10^{-10} \text{gg}$: m_s is either the mass of a particle or the equivalent mass of radiation in BH. $m_s > m_{sr}$ is showed that, m_s is heavier than m_{sr} , i.e. $m_s = \kappa T_s / C^2$ ($T_s > T_b$), or $m_s = h/C\lambda_s$ ($\lambda_s < \lambda_{sr}$), so, m_s can only exist inside Event Horizon and has no way to flee out from Event Horizon.

(ii). If $m_s < m_{sr}$, $M_b m_s < 1.187 \times 10^{-10} \text{gg}$: m_s cannot exist inside BH. **In reality, particles and radiations of ($m_s < m_{sr}$) would be impossible to exist in any BH, because all BHs were formed at the state of extremely high energy and temperature.** If by any chance some $m_s < m_{sr}$ appeared in a BH, they would flee out from Event Horizon as Hawking radiation.

(iii). If $m_s = m_{sr}$, $M_b m_s = M_b m_{sr} = 1.187 \times 10^{-10} \text{gg}$, what will happen? In reality, energy of m_{sr} either as a moving particle or as a vibrant radiation would not have an exact same value, but only have an instantaneous value at any instant, because m_{sr} certainly has **energy-fluctuation** on or closely linked to Event Horizon. Any tiny decrease in instantaneous temperature and in kinetic energy of m_{sr} at state of the lowest energy would lead increase in its tiny potential energy and decrease in R_b . Conversely, a little instantaneous smaller R_b would let more reduction of kinetic energy of m_{sr} and finally let m_{sr} flee out from Event Horizon. That is the real reason why all BHs could emit energy-matters to outside and shrink its size. That is a reasonable explanation to Hawking radiation with classical theories.

3. More calculations and further analyses

(i). Suppose n_i are total numbers of particles and radiations in a BH of M_b , so,

$$n_i = M_b / m_{sr} = M_b C^2 / \kappa T_b \quad (3a)$$

A. To $m_t = 10^{-5} \text{g}$:

$$n_i = m_t / m_{sr} = 10^{-5} / 1.187 \times 10^{-5} = 0.89 \approx 1$$

$$n_i = m_t C^2 / \kappa T_b = 10^{-5} \times 9 \times 10^{20}$$

$$/ (1.38 \times 10^{-16} \times 0.8 \times 10^{32}) = 0.815 \approx 1$$

B. To $m_{om} = 10^{15} \text{g}$:

$$n_i = m_{om} / m_s = 10^{15} / (1.187 \times 10^{-25}) = 0.84 \times 10^{40}$$

$$n_i = m_{om} C^2 / \kappa T_b = 10^{15} \times 9 \times 10^{20}$$

$$/ (1.38 \times 10^{-16} \times 0.8 \times 10^{12}) = 0.813 \times 10^{40}$$

C. To $M_u = 10^{56} \text{g}$:

$$n_i = M_u / m_s = 10^{56} / (1.187 \times 10^{-66}) = 0.84 \times 10^{122}$$

$$n_i = M_u C^2 / \kappa T_b = 10^{56} \times 9 \times 10^{20}$$

$$/ (1.38 \times 10^{-16} \times 0.8 \times 10^{-29}) = 0.815 \times 10^{122}$$

The same results (values) of n_i calculated with two different formulas in three BHs clearly shows that, all theories and laws, especially (2d) about BHs applied in this article are almost fully correct.

(ii). λ_{sr} --Wavelength of radiation m_{sr} on or closely linked to Event Horizon, ν_{sr} —frequency of radiation m_{sr} ,

$$\begin{aligned} \text{From (2e), } \lambda_{sr} &= h/(m_{sr}C) = C/\nu_{sr} & (3b) \\ \text{In case } m_{sr} &\approx 10^{-5}\text{g, } \lambda_{sr} &= 2.2 \times 10^{-32}\text{cm} \\ \text{In case } m_{sr} &= 1.187 \times 10^{-25}\text{g, } \lambda_{sr} &= 1.86 \times 10^{-12}\text{cm} \\ \text{In case } m_{sr} &\approx 1.187 \times 10^{-66}\text{g, } \lambda_{sr} &= 1.86 \times 10^{29}\text{cm} \end{aligned}$$

(iii). From formula (1c), $\tau_b \approx 10^{-27} M_b^3$ (s),
 $d\tau_b \approx 3 \times 10^{-27} M_b^2 dM_b$ (3c)

Let $dM_b = \text{one } m_{sr}$, hence, $d\tau_b$ is the needed time of emitting a Hawking radiation m_{sr} .

$$\begin{aligned} \text{To } m_t &= 10^{-5}\text{g, } d\tau_b &\approx 3 \times 10^{-42}\text{s} \\ \text{To } m_{om} &= 10^{15}\text{g, } d\tau_b &\approx 3.6 \times 10^{-22}\text{s} \\ \text{To } M_u &= 10^{56}\text{g, } d\tau_b &\approx 3.6 \times 10^{19}\text{s} \approx 10^{12}\text{yrs} \end{aligned}$$

4. Some other more important conclusions

Table 1. m_t, m_{om}, M_u , formulas

	m_t	m_{om}	M_u	formulas
mass of BH,	10^{-5}g	10^{15}g	10^{56}g	
R_b (cm)	1.5×10^{-33}	1.5×10^{-13}	1.5×10^{28}	(1a)
T_b (k)	0.8×10^{32}	0.8×10^{12}	0.8×10^{-29}	(1b)
τ_b (s, yrs)	10^{-42}s	10^{10}yrs	10^{133}yrs	(1c)
ρ_b (g/cm ³)	7×10^{92}	7×10^{52}	7×10^{-30}	(1e)
m_{sr} (g)	1.187×10^{-5}	1.187×10^{-25}	1.187×10^{-66}	(2d)
ni	1	10^{40}	10^{122}	(3a)
λ_{sr} (cm)	2.2×10^{-32}	1.86×10^{-12}	1.86×10^{29}	(3b),(4a)
$d\tau_b$	$3 \times 10^{-42}\text{s}$	$3.6 \times 10^{-22}\text{s}$	10^{12}yrs	(3c)
ν_{sr} (s ⁻¹)	1.4×10^{42}	1.6×10^{22}	1.6×10^{-19}	(4b)
ν_r (s ⁻¹)	0.3×10^{42}	0.28×10^{22}	0.28×10^{-19}	(4c)

Values listed in Table 1 above are results calculated according to all relative formulas.

(i). From formulas (2b) and (3b),

$$\lambda_{sr} = 4\pi R_b \quad (4a)$$

Formula (4a) above indicates:

In case any radiations m_s of ($\lambda_s < 4\pi R_b$) in BH, they had no chance to flee out from BH.

In case any radiations m_s of ($\lambda_s > 4\pi R_b$), it had no chance to exist in BH.

In case a radiation m_{sr} of ($\lambda_{sr} = 4\pi R_b$), it only was at the state of the lowest energy (i.e. trough) to have the chance to flee out from BH through Event Horizon as Hawking radiation. Moreover, the **Event Horizon of any BH is not a rigid shell, but a virtual spherical surface with radius R_b** , it cannot obstruct radiations m_{sr} , which energy are locating at the trough of energy-fluctuation, to go away easily from Event Horizon. That is the real reason for any BH to emit Hawking radiation and then to shrink its size R_b . Otherwise, BHs would be eternal monstrosities in nature.

Thus, emitting Hawking radiation is only the spontaneous action of any BH and is the inevitable outcome caused by the regulative motion of matter

in any BHs, it cannot be either stopped, induced or brought by any exterior natural forces. Therefore, no matter whether a pair of “virtual particles” in vacuum would come out or not, all BHs could emit their Hawking radiations as usual.

Checking up values of R_b and λ_{sr} on Table 1, it can be clearly seen that formula (4a) is fully right.

(ii). Owing to emitting Hawking radiations m_{sr} and even **energy-fluctuation of m_{sr}** , the Event Horizon (R_b) of any BH would always cause a shrink frequency ν_r . The coincidence between shrink frequency ν_r of R_b and vibrant frequency ν_{sr} of radiations m_{sr} is analogous to some resonance and is more beneficial to m_{sr} at the state of the lowest energy to flee out as Hawking radiations.

Let ν_{sr} = frequency of m_{sr} on Event Horizon,

$$\begin{aligned} \nu_{sr} &= C/\lambda_{sr} & (4b) \\ \text{To } m_t &= 10^{-5}\text{g, } \nu_{sr} &= 1.4 \times 10^{42}\text{s}^{-1} \\ \text{To } m_{om} &= 10^{15}\text{g, } \nu_{sr} &= 1.6 \times 10^{22}\text{s}^{-1} \\ \text{To } M_u &= 10^{56}\text{g, } \nu_{sr} &= 1.6 \times 10^{-19}\text{s}^{-1} \end{aligned}$$

Let ν_r = shrink frequency of R_b due to emitting a single m_{sr} .

From formula (3c), $d\tau_b$ is the needed time to emit a single m_{sr} , then, $v_r = 1/d\tau_b$,

$$v_r = 1/d\tau_b = 1/3 \times 10^{-27} M_b^2 m_{sr} \quad (4c)$$

$$\begin{aligned} \text{To } m_t = 10^{-5} \text{g,} & \quad v_r = 0.3 \times 10^{42} \\ \text{To } m_{om} = 10^{15} \text{g,} & \quad v_r = 0.28 \times 10^{22} \\ \text{To } M_u = 10^{56} \text{g,} & \quad v_r = 0.28 \times 10^{-19} \end{aligned}$$

Comparing calculated values above between v_{sr} of (4b) and v_r of (4c), it can be seen that,

$$v_{sr} = n v_r = 6 v_r, n = 6, \quad (4e)$$

From formula (4c), v_r just indicates that, shrink frequency v_r of R_b only cause from a single Hawking radiation m_{sr} emitted out from BH. However, from formulas (2a), (2b) and (2d), it is defined that, any BH would simultaneously emit 6 m_{sr} together, but not a single m_{sr} . Thus, in formula (4c), the value of v_r gotten by emitting a single m_{sr} in time of $d\tau_b$ should be changed by 6 m_{sr} simultaneously emitted together in the same time of $d\tau_b$, so, a new shrink frequency v_r of R_b should become $v_r = 6 v_r = v_{sr}$. Thus, formula (4e) is still right, and on Table 1, values of v_{sr} are just equal to values of $(6 \times v_r)$.

Schwarzschild's BH is a perfect ball-body; it would have many radiations with the same frequency on or closely linked to Event Horizon, they could simultaneously flee out together at the state of their instantaneously lowest energy. Therefore, **Hawking radiations originated from resonance between emitting ($n \times m_{sr}$) Hawking radiations from BH and shrinkage of Schwarzschild's radius R_b with emissions of Hawking radiations.**

Under the condition of emitting n Hawking radiations (i.e. $n \times m_{sr}$) together, let λ_{srn} —a pretended overlapped wavelength of ($n \times m_{sr}$), so,

$$\lambda_{srn} = \lambda_{sr} / n \quad (4f)$$

From (2b), (3b) and (4a),

$$\lambda_{srn} = 4\pi R_b / n \quad (4g)$$

$$\text{In case } n = 6, \lambda_{srn} = 2\pi R_b / 3 \approx 2R_b \quad (4h)$$

(iii). When a BH took in energy-matters or emitted out Hawking radiations, its R_b would have some increase or decrease. Correspondingly, λ_{sr} of radiations in BH would be changed a little more, because $d\lambda_{sr} = 4\pi dR_b$, **it is just red shift caused by gravity.** The change ($d\lambda_{sr}$) of λ_{sr} of a radiation is linear, but the change (dR_b) of R_b for a BH may indicate the change of spherical surface of a BH.

(iv). On Table 1, at M_u column, on Event Horizon of our universe, $m_{sr} = 1.187 \times 10^{-66}$ g, its $\lambda_{sr} = 1.86 \times 10^{29}$ cm, probably, m_{sr} might be gravitons to have been sought by scientists for many decades, if gravitons would have really existed all the time.

(v). The explorations to mysterious number “6” appeared in this article

The mysterious number “6” has appeared in this article many times and will be studied below.

In formula (2a), $n = 6$. It means that, any BH would simultaneously emit 6 Hawking radiations m_{sr} together. (2b) = (2c) and the correctness of same values of n_i calculated from (3a) have showed that ($n = 6$) is undoubtedly right and convincing.

In formula (4e), $n = 6$. In calculated values of all other BHs except minimum BH of ($m_t = 10^{-5}$ g), ($v_{sr} = 6v_r$) are right, it means that, **shrinkage of R_b come from 6 m_{sr} emitted together by a BH at the same time.** In reality, emission of 6 m_{sr} would hardly be realized at a really exact same instant, and would be always a little former or later, then, R_b would certainly shrink 6 times in the same period $d\tau_b$ with emitting 6 m_{sr} , thus, the shrink frequency v_r of R_b should become ($6v_r = v_{sr}$). The correctness of values of ($6v_r = v_{sr}$) on Table 1 has fully proved that, formulas (4c) and (4b) originated from different theories can get a same result. However, minimum BH of ($m_t = 10^{-5}$ g) is a solely exception, its $v_{sr} \neq 6 v_r$, because the upshot of minimum BH as a single particle without 6 m_{sr} would be a smashing explosion.

In formulas (4g) and (4h), in case $n = 6$, the pretended overlapped wavelength λ_{srn} of 6 Hawking radiations m_{sr} is equal to $2\pi R_b / 3 \approx 2R_b$.

The above same result of ($n = 6$) from many different formulas (2b),(2c),(3a) and (4e) appeared in above conditions many times precisely indicate that, **any BHs except minimum BH of ($m_t = 10^{-5}$ g) would always simultaneously emit out ($n = 6$) Hawking radiations together as to keep some resonance between Hawking radiations emitted by BH and shrinkage of R_b , as to let Hawking radiations have opportunity to flee out at the state of the smallest instantaneous energy from Event Horizon of any BH.**

Why must any BH always simultaneously emit 6 Hawking radiations? Any Schwarzschild BH is a spherical-symmetrical body; for keep the balance and stability of a BH at emitting Hawking radiations in all time, any BH must symmetrically and almost simultaneously emit out 6 Hawking radiations together to two opposite direction of 3 dimensions of itself.

The further verification to emitting 6 m_{sr} together from BH: if all calculated values about ($n = 6$) have no any mistakes, those values should precisely accord with following formula.

$$\begin{aligned} m_{sr} C^2 &= \kappa T_b \quad (4i) \\ \text{To } m_t &= 10^{-5} \text{g, } m_{sr} C^2 = 9 \times 10^{15}, \kappa T_b = 11 \times 10^{15} \\ \text{To } m_{om} &= 10^{15} \text{g, } m_{sr} C^2 = 1.07 \times 10^4, \kappa T_b = 1.1 \times 10^4 \\ \text{To } M_u &= 10^{56} \text{g, } m_{sr} C^2 = 1.07 \times 10^{-45}, \kappa T_b = 1.1 \times 10^{-45} \end{aligned}$$

(vi). The further analyses to minimum BH of ($m_t = 10^{-5}g$)

From formula (2d), $M_b m_{sr} = hc/(8\pi G) = 1.187 \times 10^{10}gg$, it can be seen that, ($m_t \approx 10^{-5}g \approx m_{sr}$) is just a result of approximate calculation. The precise calculations and analyses are cited below.

Formula (2d) is deduced from (2a), i.e. m_{sr} in (2d) is just one of 6 m_{sr} emitted from a BH at the same time. Thus, to the minimum or final BHs of ($m_t \approx 10^{-5}g$), there are only two possible results.

First. If $M_b = 6 m_{sr}$, from (2d), $M_b^2 = 6hc/(8\pi G) = 6 \times 1.187 \times 10^{10}gg = 7.122 \times 10^{10}g$, so,

$$M_b = 2.667 \times 10^{-5}g, m_{sr} = M_b/6 = 0.445 \times 10^{-5}g \quad (4j)$$

Formula (4j) expresses that, minimum BH of ($M_b = 2.667 \times 10^{-5}g$) is completely composed by 6 Hawking radiations of ($m_{sr} = M_b/6 = 0.445g$). Its final fate either might violently explode as Hawking radiations or further collapse into a whole minimum BH of ($M_b = 2.667 \times 10^{-5}g$).

From formula (3a), $n_i = M_b / m_{sr} = M_b C^2 / \kappa T_b$

$$M_b / m_{sr} = 2.667 \times 10^{-5}g / 0.445 \times 10^{-5}g = 6$$

$$M_b C^2 / \kappa T_b = 2.667 \times 10^{-5}C^2 / (\kappa \times 0.3 \times 10^{32}) = 5.7$$

$$\text{Verifications: } m_{sr} C^2 = 4.05 \times 10^{-15}, \kappa T_b = 4.1 \times 10^{-15}$$

Second. Above whole minimum BH of ($M_b = 2.667 \times 10^{-5}g$) would just be a single particle of the highest energy. Thus, all BHs of ($M_b = 2.667 \times 10^{-5}g$) could only violently explode at the highest temperature of $10^{32}k$ only appeared at the genesis of our universe.

$$\text{Verifications: } m_{sr} C^2 = 24 \times 10^{-15}, \kappa T_b = 4.1 \times 10^{-15}$$

Two different results of minimum BH ($M_b = 2.667 \times 10^{-5}g$) above might have more important significance to the evolution of our universe at its genesis, but hardly exert any influence to calculated values and conclusions in this article.

It displays from calculated values that, the first result seems more correct than the second one.

(vii). In this article, many new formulas, (2b), (2d), (3a), (4a), (4c) and (4g) have been derived out. All calculated values on Table 1 have exactly proved that, the **macroscopical explanations to all characteristics**

of BHs, included Hawking radiation, with classical theories and formulas are surely effective, correct and identical. The observational evidences and examinations to (2b), (2d), (4a) and (4g) will be remained in future.

(viii). **In future, examinations of correctness to formula (2d) may be easier taken. Once the correctness of formula (2b) could be checked up by observational evidences, all classical theories and formulas applied in this article and in NCBBBH as a complete system to macroscopically solve problems about BHs would be reliably verified.**

----The End----

Correspondence to:

Dongsheng Zhang
17 Pontiac Road
West Hartford, CT 06117-2129, U. S. A.
Email: ZhangDS12@hotmail.com

References

- [1] Dongsheng Zhang: New Concepts to Big Bang And Black Holes—Both Had No Singularity at All (Part 1).
- [2] Dongsheng Zhang: New Concepts to Big Bang And Black Holes—Both Had No Singularity at All (Part 2). Two articles above were published on magazine "Nature and Science", 2(3), 2(4),3(1), or debate-001, 2004, ISSN:1545-0740, Published by Marsland Company, P. O. Box 753, East Lansing, Michigan, MI 48826 U.S.A. Or <http://www.sciencepub.org/nature/debate-001> and <http://www.sciencepub.org/nature/0203> 0204 <http://www.sciencepub.org/nature/0301>.
- [3] John & Gribbin: Companion to The Cosmos, ISBN 7-5443-0145-1, Hainan Publishing House, China, 2001, 9.
- [4] Wang, Yong-Jiu: Physics of Black Holes; Hunan Normal University Publishing House, China. 2000.
- [5] Formula (13bd) in Part 2 of NCBBBH i.e. [2].
- [6] He, Xiang-tao: Observational Cosmology. Science Publishing House. Beijing, China. 2002.

On the Parabolic Curve of Primary Mirrors

Kyle DeGrave

kyledegrave3@hotmail.com

Abstract: In order for a parabolic mirror to work, light has to reflect off of every point on it and be directed in a straight line to the focus. With this in mind, we know a light ray traveling parallel to the y-axis and reflecting off of the point (x, f) has to be directed to the focus in a straight line parallel to the x-axis. In order for a vertical light ray to reflect in this way, the point (x, f) on the mirror has to have a slope of 45 degrees or, in other words, a slope of one. This means that the derivative of the parabolic function at the point (x, f) has to equal 1. [Nature and Science. 2006;4(2):23-24].

Keywords: parabolic curve; parabolic mirror

In order to make a reflecting telescope such as a Newtonian Reflector, the primary mirror is often ground into the shape of a parabola. The reason for this is that when light enters the telescope tube, it is reflected off of the parabolic mirror and, due to the unique parabolic shape, is focused at a single point (the focus) which is a certain distance away from the center of the mirror (the focal length). The purpose of this paper is to try to describe which parabolic curve is suitable to fit a known focal length. The general solution has been known for a long time, but I was able to use a kind of guess and check method to find a similar solution on my own. This is one way in which the solution can be derived. We will assume the parabola is centered at the origin, so we know the general form of the parabola will be similar to $y = ax^2$ where a is some particular coefficient depending on the given focal length.

In order for a parabolic mirror to work, light has to reflect off of every point on it and be directed in a straight line to the focus. With this in mind, we know a light ray traveling parallel to the y-axis and reflecting off of the point (x, f) has to be directed to the focus in a straight line parallel to the x-axis. In order for a vertical light ray to reflect in this way, the point (x, f) on the mirror has to have a slope of 45 degrees or, in other words, a slope of one. This means that the derivative of the parabolic function at the point (x, f) has to equal 1.

So, knowing that the parabolic function will take the form $y = ax^2$, and that the derivative of this function evaluated at the point (x, f) must equal 1, we can figure out the general equation for any parabolic mirror with a particular focal length.

Take the case where f , the focal length, equals 4. In order to find the x-coordinate for (x, f) we need to solve $y = ax^2$ for x .

$$4 = ax^2$$

$$\begin{aligned} (4/a) &= x^2 \\ (2/\sqrt{a}) &= x \end{aligned}$$

We know that at the point $((2/\sqrt{a}), 4)$ the slope of the parabolic curve must equal 1. To find an equation for the slope of the tangent line to the parabolic curve at any point we take the derivative of $y = ax^2$.

$$\begin{aligned} y &= ax^2 \\ y' &= 2ax \end{aligned}$$

We know $x = 2/\sqrt{a}$ and that the slope at this point has to be 1. Plugging in $y' = 1$ and $x = 2/\sqrt{a}$ we get:

$$1 = (4a)/\sqrt{a}$$

Rearranging we get:

$$\begin{aligned} \sqrt{a} &= 4a \\ a &= 16a^2 \\ 1 &= 16a \\ 1/16 &= a \end{aligned}$$

Plugging a back into our original parabolic equation we get:

$$y = (1/16)x^2$$

which will produce a focal length of 4.

We have just found the parabolic equation for a mirror that produces a focal length of 4. However, we can generalize this equation for *any* focal length. Take f to be the focal length, but this time, instead of assigning a value to f , we will leave it like it is.

$$\begin{aligned} f &= ax^2 \\ f/a &= x^2 \\ \sqrt{f}/\sqrt{a} &= x \end{aligned}$$

$$f^2 = 2ax$$

$$l = (2a \cdot \sqrt{f}) / \sqrt{a}$$

$$\sqrt{a} = 2a \cdot \sqrt{f}$$

$$a = 4fa^2$$

$$l = 4fa$$

$$l/(4f) = a$$

Therefore, by plugging a back into the parabolic equation we get the general solution:

$$y = 1/(4f)x^2$$

where y is the curve that a parabolic mirror takes with any focal length f .

Correspondence to:

Kyle DeGrave

kyledegrave3@hotmail.com

PEACE VIEWSLETTER

Philosophical implications of Universal Theory of Relativity: Role of God in the Universe, Time, Determinism, Quantum Mechanics

N. P. Singh

javedjamil@rediffmail.com

An American journal, "Nature and Science" has, in its March issue of 2005, published a paper authored by Dr. Javed Jamil, entitled, "Rediscovering the Universe: the Beginning of the Final Revolution", which is in fact a part of the recently published book by the author under the same title. The paper published in the journal is about the philosophical implications of the Universal theory of Relativity, presented by Dr. Jamil in his book. This theory is an open challenge to the currently popular theory of Physics, which is based primarily on Einstein's Special and General theories of Relativity and Hubble's theory of expanding universe, and if proved correct, will revolutionise not only physics but also other natural and philosophical sciences. Dr. Jamil's theory consists of three basic postulates: First, the speed of light is not constant (as theorised by Einstein) but stable. He has for the first time in the history of Physics provided a theoretical basis to assert that light speed is not the highest speed possible, and in fact much greater speeds are possible. Second that the universe is not expanding (as theorised by Hubble) but rotating as a whole (apart from the motions of its constituents) around its axis. Not only this will explain the red-shift, but will also answer most of the unanswered questions of Physics. Third that gravity propagates at a huge speed, and not with the speed of light, as theorised by General theory of light. The book discusses structural, functional and philosophical implications of the theory in separate chapters. The American journal has published the philosophical implications, including Role of God, Determinism, Time, Quantum Mechanics, etc. Here, the portion related to "Role of God" is being reproduced. The full text of the chapter can be read at the website of "Nature and Science":

<http://www.sciencepub.org/nature/0401>

<http://www.sciencepub.org/nature/0401/01-0107-javedjamil.doc>

<http://www.sciencepub.org/nature/0401/01-0107-javedjamil.pdf>

[Nature and Science. 2006;4(2):25-30]

By Dr. N. P. SINGH

Rediscovering the Universe: the Beginning of the Final Revolution

Javed Jamil

javedjamil@rediffmail.com

Philosophical implications, Role of God

From time immemorial man has talked of God. Most of the humans have believed God created the universe and sustains it. A minuscule percentage of humans have argued that man created or invented God and their psychological and social needs sustain Him. In sciences too there have always been a huge controversy on the role of God in the creation and sustenance of the universe. The evolution of knowledge including natural sciences in the last two centuries has been under the influence of what I call Economic Fundamentalism. Industrial Revolution resulted in progressive strengthening of the grip of the industrialists over the

world and the ideology they propagated. The impact of the economic fundamentalism on the growth and form of sciences has been one of the issues that I have discussed in my earlier works, "The Devil of Economic Fundamentalism" and "The Killer Sex". I feel it is worthwhile to reproduce parts of those discussions here:

"Science is the name given to the efforts for arriving at the truth and knowing the realities. It unfolds mysteries of nature and explains how scores of natural forces combine to maintain perfect harmonious equilibrium essential for the sustenance of the universe and the survival of all living beings. It teaches us how to avail ourselves materials and energies for different

purposes. It would however be dangerous to presuppose that science is merely an informer and has nothing to do with our morals. What is incontrovertible is that science too, like religion, has been and is being misused by the vested interests. The dagger of blame falls not on science, but on those who misappropriate it. A general empathy towards religion that was the outcome of maledictory campaigns against it by the forces of economic fundamentalism influenced scientists too, who strove to present science as an antidote to religion. Religion had already been equated with orthodoxy and retrogression. It was therefore natural for the emerging edifice of science to maintain a safe distance from the faith. Hence, when science discovered that there exists a most wonderful equipoise in the universe that keeps life intact, that there seems to be a common cause of all the causes (or a common force behind all the forces), and the common cause has to be cognisant of the needs of all the creatures, scientists and philosophers named this common cause Nature. Had it been called God, the avowed antagonism of religion by science would have suffered a major setback. The acceptance of the One by science could have been a big boost for moralists. Materialists could have faced encumbrances in their naked pursuit of money.

Thus, numerous laws governing the vast universe were labelled not as God's or Creator's Laws but the laws of Nature. The laws of gravitation and motion, for instance, were called Newton's Laws of Gravitation and Motion rather than the Creator's Laws, as if Newton created these laws, who in fact only tried to elucidate them. Despite all these attempts to banish God from the realm of science, the truth is that science cannot move an inch without assuming the presence of a being who is all-seeing, all-knowing, all-powerful, eternal, wise, calculating and all-pervading. It has only tried to infatuate itself by calling this omnipotent, omnipresent and omniscient being as Nature. Can science enlighten us how particles, or space, or waves forming "Nature" possess faculties of intelligence and wisdom? Can it explain why all the physical laws remain the same everywhere in the universe. (Einstein's theory of relativity postulates that physical laws are the same in all co-ordinate frames all over the universe.) Science claims itself to be the truth and nothing but the truth, or an effort to arrive at the truth. But its signal failure has been its inability to recognise the greatest truth of the universe. It is not that science transformed its exponents into atheists. In fact, the greatest scientists of the world including Einstein, Darwin and Newton had an unshakeable belief in the presence of the One. But what their hearts were cognisant of, their pens could not describe in a scientific jargon. It was less perhaps because they found their belief scientifically untenable and more because they were scared of becoming targets of anti-religion elements that had a dominating presence

in society. Both capitalism and socialism, the two great faces of economic fundamentalism had anathema for God whose fear and love created "unnecessary" impact on human morals."

In short, the development of modern sciences has been in an environment of antipathy towards religion. It was therefore accepted as a fundamental principle by scientists all over the world that God has to be kept out of science at all costs. Heisenberg confirms this when he says:

"The mechanics of Newton and all the other parts of the classical physics constructed after its model started from the assumption that one can describe the world without speaking about God or ourselves. This possibility soon seemed almost a necessary condition for natural sciences to grow."

Why should natural sciences start on that assumption when there was no need to disprove God? Had God's existence been accepted, what bad could it have done to sciences? Still, sciences could have tried to understand "God's mind" and His creation and the laws that governed the universe. But this would have weakened the position of the economic fundamentalists against religion, which had belief in God as the foundation on which it rested. Religion posed huge risks to the advance of the economic designs of the forces of economic fundamentalism. Religion promoted morality, abstinence from certain practices like alcohol, gambling, extramarital sex and simplicity in life. All these things were seen as the foes of "development", and religion therefore was not acceptable. Faith in God and His punishment to the evildoers would greatly reduce the speed of the "growth". If scientists started confirming the existence of God, it would make life difficult for the big business. They will find it hard to promote consumerism and commercialise evils; there will be no place for bars, beaches, casinos, brothels, night-clubs and pornography in such a dispensation.

In spite of the general antipathy in the scientific community towards religion and God, sciences could never get free of God altogether. Top scientists couldn't keep away from talking of God. Einstein and Bohr had constant debates about the role of God in the formation and functioning of the universe. In response to the idea of uncertainty that Quantum Mechanics advanced, Einstein, in the now famous duel with Bohr, remarked, "God does not play dice". To this Bohr retorted, "Don't try to tell God what to do!" While discussing the laws of science as we see today without talking of God was not unavoidable, the creation of the universe automatically warranted such discussion. Let us try to sum up the position of the current Physics about the role of God.

Scientists have always wondered the beauty of the universe, especially how it has led to the creation or evolution of intelligent beings like us. There is a certain beauty in the underlying plan. John Polkinghorne says:

"...the universe, in its rationale, beauty and transparency, looks like a world shot through with signs of mind, and maybe, it's the "capital M" Mind of God we are seeing.....there is some deep-seated relationship between the reason within (the rationality of our minds - in this case mathematics) and the reason without (the rational order and structure of the physical world around us). The two fit together like a glove."

The laws all over the universe are the same. The Question arises why. In the theory of Big Bang, there has not been an enough time for the distant regions to communicate with another, seeing that nothing can travel faster than the light, according to the theory of Relativity. Hawking says:

"Nevertheless, it leaves a number of questions unanswered:

Why was the early universe so hot?

Why is the universe so uniform on a large scale? Why does it look the same at all points of space and in all directions? In particular, why is the temperature of the microwave background radiation so nearly the same when we look in different directions? It is a bit like asking a number of students an exam question. If they all give exactly the same answer, you can be pretty sure they have communicated with each other. Yet in the model described above, there would not have been time since the Big Bang for light to get from one distant region to another, even though the regions were close together in the early universe.

According to the theory of relativity, if light cannot get from one region to another, no other information can. So there would be no way in which different regions in the early universe could have come to have had the same temperature as each other, unless for some unexplained reason that happened to start at the same temperature."

Hawking has progressively grown into an agnostic as far as the role of God is concerned. He has been busy finding solutions in which the universe could be thought to have had no beginning. In the above writing, he has raised an interesting example of students solving the same question with the same answer. If they have responded with exactly the same answer, there can be two reasons. First reason has been given by Hawking that is they must have had communicated with one another. But if there can be a surety that they could not communicate with one another, then what? There still remains a possibility, and that possibility is that they might have received the dictation from the same source.

In the Big Bang models based on the General Theory of Relativity, singularity was unavoidable. Penrose-Hawking Theorem proved that singularity at time zero is inevitable, and that time-space fabric would break down at the singularity. The Big Bang could not have occurred, it was argued, without the creation by God. But this position has not been acceptable to those

who do not want the existence of God within the realm of sciences. So, efforts have been on led by Hawking to find solutions where we can have a no-boundary situation for the universe. Hartle and Hawking proposed a situation where the dimension of time becomes fuzzy turning into a fourth spatial dimension as we approach towards singularity. At that point, time becomes meaningless. And that makes Hawking swell with confidence, which made him remark, "So long as the universe had a beginning, we could suppose it had a creator. But if the universe is really completely self-contained, having no boundary or edge, it would have neither beginning nor end: it would simply be. What place then, for a creator?"

But the truth remains that even this proposition does not abandon the concept of the beginning of the universe altogether. Because there again is an event where time becomes meaningful from a meaningless situation and the universe can be considered to have begun when the time becomes meaningful. The position of scientists regarding the beginning of the universe due to Divine creation has been conceded in an article written to counter the more popular belief. The article captioned "Theism, Atheism and the Big Bang Cosmology" by Quantum Smith, published in Australian Journal of Philosophy, March 1001 says:

"The idea that the big bang theory allows us to infer that the universe began to exist about 15 billion years ago has attracted the attention of many theists. This theory seemed to confirm or at least lend support to the theological doctrine of creation ex nihilo. Indeed, the suggestion of a divine creation seemed so compelling that the notion that 'God created the big bang' has taken a hold on popular consciousness and become a staple in the theistic component of 'educated common sense'. By contrast, the response of atheists and agnostics to this development has been comparatively lame. Whereas the theistic interpretation of the big bang has received both popular endorsement and serious philosophical defence (most notably by William Lane Craig and John Leslie, the nontheistic interpretation remains largely undeveloped and unpromulgated."

Another important discussion is centred about the Anthropic Principle. Before the 16th Century, the general understanding of man's position in the universe was based mainly on theological and other ancient concepts, which were represented by Ptolemaic principle. This principle states that we have a privileged position, perhaps in the centre of the universe. Galilee and Copernicus countered this and went on to pronounce that we have no privileged position in the universe. They argued that the part of universe we are living in was like any other part of the universe. But the 20th century cosmology again led to a visible transformation in thinking. It was argued that we ourselves are in fact

the products of the evolution of the universe, and had we not been there, there would have been none to appreciate the beauty of the universe. This position is represented by three principles called Anthropic Principles. These three are Trivial, Weak and Strong. Trivial principle regards the existence of human beings as nothing but a mere datum and does not give it any other significance. The Weak and Strong Anthropic principles are based on the acceptance that the existence of human beings is extraordinary. The creation of the human being depends upon a series of striking coincidences. Hawking says, "The remarkable fact is that the values of these numbers seem to have been very finely adjusted to make possible the development of life." The striking coincidences that led to the formation of intelligent life have been briefly summed up on a website, "St John in Wilderness: Physics and Faith":

"Elements up to Lithium-7 were produced in the Big Bang. All heavier elements were made later inside stars. Hence all of us are "star-stuff". Most of the molecules making up our bodies using elements manufactured in an earlier generation of stars that enriched the interstellar medium through their stellar winds or when they died in supernovae. Our own solar system then formed from this enriched interstellar medium, which contained the elements necessary for life.... However, the synthesis of the heavier elements is difficult -- the only reason they are produced at all is the extraordinary coincidence that carbon has an energy level that is nearly the same as the energies of three alpha particles (helium nuclei) inside a star. This correspondence allows the reaction: three Helium-4 nuclei colliding to form one carbon-12 nuclei ($3\text{ }^4\text{He} \rightarrow \text{ }^{12}\text{C}$) to occur with a high enough probability that a reasonable amount of carbon can be made, and from carbon, still heavier elements. (Physicists say the "cross-section" for the process is resonant, which is a consequence of the matching of the energy levels).

"Paul Dirac (1902-1984), one of the founders of quantum mechanics, noted that very large dimensionless numbers often arise in particle physics and cosmology. For example, ratio electrostatic force/gravitational force between a proton and electron= 0.23×10^{40} ; ratio of cosmological distance horizon ("radius of the universe") and "classical electron radius"= 3.7×10^{40} . It can be shown from the physics of stars that these large ratios are required for the lifetime of the average star to be in the range of billions of years. The rate of expansion of the universe is to be such that several generations of stars have time to age that is, the laws of physics and the initial conditions of the universe seemed "tuned" to allowing several generations of stars to live and die (a requirement for the production and dissemination of the heavier elements). The lifetime of an average star has to be sufficiently long to potentially allow a process such as the evolution of life to occur."

Hawking describes the extraordinary combination of coincidences as follows:

"... For example, if the electric charge of the electron had been very slightly different, stars either would have been unable to burn Hydrogen and Helium or else would not have exploded. Of course, there might be other forms of intelligent life, not dreamed of even by writers of science fiction, that did not require the light of star like the Sun or the heavier chemical elements that are made in stars and are flying back into space when the stars explode. Nevertheless, it seems clear that there are relatively less ranges of values for the numbers that would allow the development of any form of intelligent life. Most sets of values would give rise to universes that, although they might be very beautiful, would contain no one able to wonder at that beauty. One can take this either as evidence of a divine purpose in Creation and the choices of the laws of science or as support of the strong Anthropic principle."

But even the arguments of strong and weak Anthropic principle have been dismissed by those who do not want to see any Designer behind all this design. They try to explain this on the basis of random selections. For example, the same website ("St John in Wilderness: Physics and Faith") counters this on the basis of Execution Parable. L:

"A perspective on the explanations of "many universes" or "many domains" (Weak Anthropic Principle) versus a Designer (Strong Anthropic Principle) is offered by the Execution Parable of philosopher John Leslie..... You are blindfolded and about to be executed by ten expert marksmen aiming at your chest. The officer gives the order to fire the shots ring out, and you find you are still alive, unscathed! What is the rational explanation for your survival? Leslie suggests there are only two rational explanations: there were an enormous number of executions that day.

Occasionally even the most expert marksman will miss, and you happened to be in the one execution where all the marksmen missed, (and second that) your survival was intended and the marksmen missed by design."

This is difficult to understand however why there is insistence on finding a solution without God when a solution with God deals problems much easily. For example, scientists try to argue that coincidences and accidents, random selections can occur repeatedly in a way that it can lead to evolution of a better and more intelligent life. But they are not ready to accept that more than the probability of finding innumerable number of such coincidences in a way that they lead to what is desirable, the more probable is the presence of a Being who is designing this. This is like assuming numerous coincidences that led to the making of car rather than accepting that it has been designed and manufactured by a company.

It is also entirely incomprehensible why Occam's Razor is also disregarded while discussing the role of God. According to the well known scientific principle, "Pluralitas non est ponenda sine neccesitate". This means the number of entities required for explaining anything must be kept at minimum. If there are many ways to explain something, the easiest and straightest one should be preferred. If there are many roads to reach a specific point, the straightest one should be used. This principle was described by a mediaeval philosopher, Occam of Razor, and is still regarded a strong principle in all sciences. Why then is this principle forgotten when we find that the easiest way to describe the creation and evolution of the universe and intelligent life within it is to accept the presence of an All-Knowing, All-Powerful, Wise God.

The UTR and God

Though even based on the knowledge of the universe we have till this date, it is easier to accept than not accept God, the Universal theory of Relativity (UTR) presented by this author can prove to play a decisive role in arriving at the truth. The UTR says that the universe as a whole rotates on its axis. It is this rotation, which has led to the creation and sustenance of the universe, and is responsible for all the properties of the universe as a whole and as its parts. Now, the rotation requires regular supply of energy from outside. Thus the universe exists because it is rotating due to an incessant supply of energy from outside the universe, and would cease to function as soon as this supply is discontinued. As the supply of energy is stopped, the Uniglobe will stop rotating and all its components will lose their individual and collective properties. The universe will be dead. The rotation of the universe as a whole thus leads to two fundamental conclusions. First, if the Uniglobe is rotating, it must be rotating relative to a preferential frame of reference that surrounds it on all sides. Second, the universe is having an uninterrupted supply of energy from that external source. That external source can be none other than God.

The UTR completely and dramatically changes the relationship between the universe and God. While all the theories of Physics describe the parts of the universe, their properties, their motions, etc, the UTR in addition describes the universe as a whole (Uniglobe). The universe becomes an entity in itself, which can be seen separately from its components. Its relationship with the Creator becomes more profound and subtler. The universe does not merely remain a container of matrices and forces that it is, in accordance with the present theories, but becomes an existence in itself that bows to God, by rotating itself relative to Him, in response to the supply of provision to it. The universe and God become intimately connected. The former

becomes a well-organised state and the later its majestic king. The role of Creator is not limited to somehow cause the beginning of the universe or the Big Bang, after which the universe takes control of itself and the role of God ends forever. In the aftermath of the UTR, it can be seen that the role of God becomes permanent. It ceases not for an iota of time anywhere in the universe. He makes the universe rotate and creates it. He keeps rotating it by continuous supply of the provision for its existence. If the laws in the universe are regularly in force and the energy and mass retain their status, it is on the account of the continuous rotation of the universe at God's behest. Ultimately, He may choose the time of its death and preside over its demise by deciding to abruptly suspend or terminate the supply of energy causing the rotation of the universe to stop within no time. The universe will not die because the entropy would ultimately become universal, as demanded by the second law of thermodynamics. It will also not die because, due to long, continuous burning of fuel, stars will lose their lustre. Finally also not because, due to freezing of the planet, animals and planets including human beings will be deprived of the source of their life. The universe will take its last breath because God may decide enough is enough. He may think of replacing it with another kind of the universe with another set of laws and principles. Or He may want to resuscitate the world to see what they did in the previous world.

According to the current theories based mainly on General theory of Relativity, the universe even when it began had certain properties that were not well defined though, because they were infinite, mathematically. But the universe existed as a singularity, which had infinite mass-energy. How can it be called a non-existing universe? It was in fact existing from an infinite time. It can be argued that time did not start at the Big Bang but started its ticking in a way that it could then onwards be measured. The universe then existed at the singularity; the Big Bang only led to its huge expansion. That was no creation of the universe itself, but the beginning of the creation of the components of the universe. In a way, it can be said that the universe ceased to exist as a single body after the Big Bang, and instead transferred its life to its individual components. The Big Bang, in a way, was not the birth of the universe but its death. In the UTR instead, the universe had real birth, and the time had real beginning. The universe before had no structural or functional existence, and time had no existence at all. The process of the birth began as soon as the universe began to rotate. The process of creation of the universe had three main stages: Pre-(Big) Burst stage, Big Burst and Post-Burst stage. Pre-Burst stage can be regarded as the foetal stage, and at the Big-Burst, the universe was delivered. Then followed the growth of the universe.

It is interesting to see how the UTR blends physics and metaphysics together. It establishes a lasting, never-ending relation between God and the universe. God supplies the universe the provision for its existence and the universe thanks Him by rotating relative to Him, which is its bowing or prostration to God. The UTR has proposed that every particle tries to achieve the highest speed possible and goes towards the periphery of the universe; this speed is slowed by its own weight and the effect of the surroundings on it. Metaphysically, as soon as God started distributing the provision, all particles speeded to receive their shares, and thanked God by rotating individually and collectively relative to Him. It is this combination of providing by God and thanking by the creatures that sustains the universe.

What was the purpose of the creation? Why did God create the human being? These are questions that again lead to the overlapping of physics and metaphysics. Some take the existence of the human being as the sign of God, others the result of Strong Anthropic principle. The UTR takes this to new heights. Before the beginning of the rotation of the universe, God was alone. There was none to recognise Him, to describe His creative designs, His bounties and His powers. He made a plan so that he would be recognised. First he created the universe, which recognised Him by prostrating to Him and by following the Laws He decreed. Every single particle and portion of space would rotate with the rotation of the universe relative to Him, which in a way meant submitting to Him. Their submission, however, was of lesser quality, as they submitted not out of their free will but by their inherent nature. God's plan would ultimately lead to the creation of an intelligent being who would have the free will to submit or not submit to the commands of God. All the particles that formed man would still submit to the Creator by rotating along with the rotation of the universe, individually and collectively with its group.

But at the social and personal level, he would be free to work in accordance with the demands of God or those of his own wishes. This would give him a privileged position. He would be bestowed upon the intelligence to appreciate the beauty of the creation, to study how it works, to try to know how it was formed and to comprehend his own nature and his relationship with the universe and its creator. Thus the UTR would combine temporal with spiritual and physical with metaphysical.

Another interesting combination of physical and metaphysical is the fact that there is a relationship between God and the components of the universe based on the principle of collective existence. Atom has a nucleus at the centre, which can be described as the leader of the atomic world. The stars are the leaders of the stellar systems, and stars form galaxies, galaxies clusters and clusters super clusters. Superclusters or even larger structures like the proposed Megagalaxy form the universe. So every particle is submitting to the God individually as well as collectively in various groups. The Uniglobe submits to Him with all its constituents. God may choose in the next universe a principle by which every individual particle rotates separately relative to God.

God does not play dice nor He needs to be told what to do. He knows what He wants, and how this has to be done. He makes man exist. He provides him the means to survive-- to admire the beauty of His creation, to ponder over the mysteries of His Empire and to endeavour to know His Mind. God has programmed man's life but has given the keyboard and the mouse to him to let him function with sufficient freedom

Correspondence to:

Dr Javed Jamil
javedjamil@rediffmail.com

Issue 22/Dated February 8, 2006

The Museum of Art and Science of Ben-Gurion University of the Negev, Beer-Sheva, Israel and a Few Responses of Visitors

Abraham Tamir

Department of Chemical Engineering at Ben-Gurion University of the Negev, P.O. Box 653, Beer-Sheva 84105, Israel, Telephone: 972-8-646-1111, Email: atamir@bgu.ac.il, Websites: <http://www.bgu.ac.il/museum>; <http://www.bgu.ac.il/museum/tmoaas>

Abstract: This paper describes the Museum of Art and Science, the first of its kind in the world. A few responses of visitors are also presented. [Nature and Science. 2006;4(2):31-33].

Keywords: museum: exhibition; art, science; art and science; God

The Museum

The two cultures - Art and Science, usually looked upon as two different entities, are practically one totality. The close interaction between the "two cultures" finds also attestation in the words of Cheng-

Dau Lee, Nobel laureate in physics: "Both, science and art are not separated from each other. There is even a similarity between them as they help us observe nature. With the help of science we can find out routines of nature. On the other hand, by means of art we can describe the emotions of nature."



Figure 1. Vertical and horizontal sections of the museum in Ben-Gurion University of the Negev

The major aim of the museum, the first of its kind in the world, established by the author of this site in 1998 is to demonstrate the Interaction Between Art and Science, namely, to bring to the attention of the viewer that Science can also be seen through the "eyes" of Art. Thus, the two cultures - Art and Science, usually looked upon as two different entities, are practically one totality. Applying this approach adds a new dimension to Art, namely, demonstrating Science by Art. For example, the famous artwork by Sandro Botticelli "The Birth of Venus", painted at about 1485, in addition to

aesthetic aspects, can be used to demonstrate Archimedes' Law, that explains why she is not sinking while standing on the shell. Most probably Botticelli did not consider this aspect while painting this artwork.

The combination between Art and Science is demonstrated here by facial combination of Albert Einstein, Mona Lisa and Leonardo Da Vinci. The reason for selecting these images is because Mona Lisa is the most famous painting in the history of Art. Leonardo Da Vinci who painted her, was probably the

first to utilize the close interrelationship between Art and Science, while Einstein was the greatest theoretical physicist of all times.



Figure 2. Responses of visitors on the museum

* "A unique and fascinating exhibition. Thank you Professor Tamir." Aaron Klug, Cambridge, England (Nobel Prize Laureate in Chemistry)

* "If only school science had been made this interesting! A fascinating trip with the brain". David Elliot, Director, the British Council

* "As one who is coming from art, the idea of combining Art & Science is wonderful. The introduction of art to the "temple of science" is a positive action, especially in our era"

* "Excellent! This is how an academic institute should look like"

* "Wonderful, too good to be true"

* "Wonderful exhibition relating two different worlds"

* "Fascinating exhibition. So nice that there is somebody who does something to arouse the thinking of students above the taught subjects, taking the soul, thoughts and logic to other worlds"

* "Very special, full of taste and very elegant"

* "Fascinating and broadening the knowledge of the pupils - your future students - either in Art and in Science"

* "Good luck on the innovative exhibition in its ideas and avenues"

* "The exhibition adds to the university. It is absolutely interesting to observe the pictures during the intervals between the lectures..."

* "It is not a regular exhibition. We will visit again"

* "I received new dimensions to old subjects"

* "Very interesting. I don't think that the artists thought scientifically while painting"

* "Eventually you found what to do with art, to explain in a simple way most important concepts in science. Until today I did not understand why and what is art for,

but to sale pictures and sculptures"

* "To bring Art & Science to the crowd"

* "Dear Abraham! You succeeded in transforming a classroom building to a colored, aesthetics place which is full of life"

* "I was always thinking that people are divided into two: those who are engaged in science in a dry and precise form, and those who are engaged in art. By observing the exhibition and your explanations, I was happy to reveal that it is possible to unite the two entities"

* "I found my self revealing dimensions and movements in places I did not realize. All respect to the creators who succeeded to transfer to the paper difficult and abstract concepts"

* "Simply fascinating! To someone who studies humanities, there is no significance to scientific concepts. But the interaction between Art & Science is so strong. It is wonderful to see surrealist artists, which I like, given to a different interpretation, different from what I have seen"

* "Dear Abraham! We were impressed of your scientific-artistic contribution and your interpretations. Good luck on the opportunity you give visitors of the university and particularly the students to enjoy aesthetics of art and the interaction between Art & Science"

* "Of all exhibits, I was most impressed by the Visitors Book. So many wishes and nice words. So if all are wishing so highly, I don't have any other choice but to join them"

* Creates an excitement! It is the best proof that Science is much but not certainly all. After all this it is much easier to believe that there is God.

Abraham Tamir

Abraham Tamir is a full professor in Chemical Engineering at Ben-Gurion University of the Negev, Beer-Sheva, Israel. In the course of his administrative career he has been also Rector of the University (1986-1990), the highest academic position.

Abraham Tamir is the author of 170 scientific articles and 10 books. He also developed an efficient gas burner, which may save about 25% of the gas consumption when applied to domestic gas stoves and outdoor cookers. In 1990, the largest manufacturer of camping equipment in Israel launched the market with a new product, the *Rotoflame Camping Cooker*, which applied successfully the new burner. In 1984 he was awarded The Michael Landau Research Prize for "Development of Domestic Stoves" and in 1991 The Bergman Prize for contribution in the development of the subject "Combustion Processes in Swirling Flows"

Abraham Tamir is considered as world expert on "Impinging-Stream Reactors", a method for intensifying technological processes. A reviewer described him once as the father of impinging streams. His achievements are summarized in his book "Impinging-Stream Reactors", published by Elsevier in 1994, which was translated also to Chinese.

In 1998 he founded the Museum on Art and Science in his University, the first of its kind in the world. He also established about 40 exhibitions on Art&Science in Israel and abroad. During 2000-2005 he acted the Associate Editor on Art and Science in the Canadian Journal of Chemical Engineering. From 2003 he is editing a column on Art and Science in the Scientific American published in Israel and from 2006 in the journal The Chemical Engineer (tce) published in England. In recent years he has been teaching a new course he developed, entitled, The Interaction Between Art and Science at Ben-Gurion University of the Negev and colleges in Israel.

Correspondence to:

Abraham Tamir
Department of Chemical Engineering
Ben-Gurion University of the Negev
P.O. Box 653
Beer-Sheva 84105, Israel
Telephone: 972-8-646-1111
Email: atamir@bgu.ac.il
Websites: <http://www.bgu.ac.il/museum>;
<http://www.bgu.ac.il/museum/tmoaas>

Thermodynamic Functions via Art

Abraham Tamir

Department of Chemical Engineering, Ben-Gurion University of the Negev, Beer-Sheva, Israel

Thermodynamics is the science engaged with the transformation of heat into mechanical work under the restrictions of four laws. By law is meant a generalization that describes recurring facts or events in nature. The 1st Law tells us that energy is always conserved, but it can be converted from one form to the other. According to the 2nd Law “there is no free lunch”, namely, heat flows spontaneously from a high temperature to a lower one, however, the opposite can only be achieved by investing work. The impossible attainability of the absolute zero is the 3rd Law, while according to the Zeroth Law, if two temperatures are equal to a third one, they are also equal to each other. A quantitative presentation of the laws requires the definition of basic functions such as volume, enthalpy, entropy, etc. A combination of these functions makes it possible to define additional ones. The major aim of this article is to illustrate these functions by means of the artworks on the back cover making them more perceptible.

We begin with *Pressure P*, the force per unit area in a fluid acting normally on a surface. It is demonstrated by the artwork of Hanoeh Piven, cartoonist, who was born in Uruguay. It is interesting to note that the concept of pressure appeared for the first time in Genesis 19:9: “They kept bringing Pressure on Lot ...”

Volume V, the space occupied by a body, is demonstrated by “Campbell’s Soup I” (1968) of Andy Warhol (1928-1987), an American pop artist.

Absolute temperature T means temperature measured on a scale, Kelvin and Rankine, with absolute zero as 0. The latter is the lowest temperature which could occur naturally, while there is no limit to how hot an object can become. It is astounding how the artwork “Homo Vitruvius” (c.1490) by Leonardo da Vinci (1459-1519) demonstrates this function T. The artwork is also a study of the proportions with the human figure inscribed in a circle and square.

Heat Q, is the energy transferred from one body or system to another as result of a temperature difference. It is demonstrated by “Eruption” (1990) of the Polish artist Jacek Yerka (1952). It was Benjamin Thompson, also known as Count Rumford of the Holy Roman Empire (1753-1814), who discovered the true nature of heat as a form of energy while operating a factory for boring cannon. In the process of boring the hole in the barrel the metal got hot. Rumford was able to show that the only explanation for this phenomenon was that the work being put into turning the drill bit was being converted into heat.

Work W, the force times the distance through which it acts, is established for two cases. Like heat, work is energy in transfer formed or invested during when a process takes place between two states. $W = 0$ is demonstrated by “Noon Rest” (1890) of Vincent van Gogh (1853-1890) a Dutch Expressionist, while “The Gleaners” (1857) by Jean-Francois Millet (1814-1875), a French realist painter, illustrates $W > 0$. The work function is very ancient. Already in Genesis 2.2 it is emphasized that by the seventh day God had finished the *work* he had been doing; so on the seventh day he rested from all his *work*.

Internal Energy U, is that energy that a substance possesses because of the motion and configuration of its atoms, molecules, and subatomic particles. In other words, it is the energy related to the inside of a body, thus, U of a system is the sum of all the microscopic forms of energy. The internal energy of a system can be changed by a flow of work, heat or both, and when these are added to a thermodynamic system, they are stored as an internal energy. The “Girl With Gloves” (1929) by Tamara de Lempicka, Polish (1898-1980) illustrates this function noting that the inside of the body is convincingly emphasized.

Potential Energy mgh, the energy that a body possesses by virtue of its position, is demonstrated by two artworks. $mgh = 0$ was advertised by Wm. Wrigley Jr. Company (1999) where that for $mgh > 0$, “The Idea” (1966) was painted by Rene Magritte (1898-1978) a Belgium Surrealist.

Kinetic Energy $mv^2/2$, the energy that a body possesses by virtue of its motion, is demonstrated by Magritte’s artwork “Time Transfixed” (1938). The surrealist presentation of a tiny locomotive emerging inconspicuously from the vent, where its smoke is nearly disappearing up the chimney, enhances the impression of speed, i.e. kinetic energy.

Entropy S of a system is a measure of its degree of disorder or randomness on the molecular scale. This quantity was introduced in the first place to facilitate the calculations, and to give clear expression to the results. From this point of view, the first and second laws of thermodynamics help to set up the foundation or entropy. Thermodynamic systems tend to react in ways that increase their entropy, namely, the amount of energy that is no longer available for doing mechanical work. If the universe is considered as an isolated system, entropy increases as matter and energy in it degrade to an ultimate state of inert uniformity. Human’s life is related to the amount of entropy in our body. Once the entropy increases to a certain level, we are no longer able to complete our required functions. We constantly increase our entropy from the day we are born. However, to maintain a (healthy) low entropy, a state of order until old age, we should take into account the kind of food that we eat and other activities we perform. The artworks, by Piet Mondrian (1872-1944), Dutch Geometric constructivist are illustrations of this function. “New York City I” (1942) represents $S = 0$ and “Victory Boogie-Woogie” (1943/44) $S > 0$.

The *Gibbs function G* is the energy available to do useful work. It is also called Gibbs free energy and given the symbol G in honor of Josiah Willard Gibbs (1839-1903) who almost single-handedly developed both the concept and the quantitative equations that describe it. The artwork by Magritte, “Perspective: Madame Recamier de David” (1951) demonstrates the situation of $G = 0$ and that of Fernando Botero (1932), Colombian, “Ball in Colombia” (1980) illustrates $G > 0$.

The last function demonstrated is “Dead State”, which is a state where the system has lost its capacity of delivering available energy. It is demonstrated by the artwork “Dying” (1990) of Alex Grey (1953) an American artist of anatomy of the body. In conclusion it is believed that the presentation of thermodynamic functions via art makes them clearer and more perceptible.

Thermodynamic functions
v i a a r t

[1] pressure . piven [2] volume . warhol [3] temperature T . da vinci [4] heat . yerka
 [5] potential energy = 0 [6] potential energy > 0 . magritte
 [7] entropy = 0 . mondrian [8] entropy > 0 . mondrian
 [9] work = 0 . van gogh [10] work > 0 . millet
 [11] kinetic energy . magritte [12] internal energy . lempica
 [13] gibbs function = 0 . magritte [14] gibbs function > 0 . botero [15] dead state . grey

Concept: A. Tamir | Design: Hadas Design

ELISA Technique

Hongbao Ma *, Kuan-Jiunn Shieh **

* Department of Medicine, Michigan State University, East Lansing, Michigan, USA. hongbao@msu.edu

** Department of Chemistry, Chinese Military Academy, Fengshan, Kaohsiung, Taiwan 830, ROC

Abstract: ELISA is the abbreviation of enzyme-linked immunosorbent assay. ELISA is a useful and powerful method in estimating ng/ml to pg/ml ordered materials in the solution, such as serum, urine and culture supernatant. This article describes the principle technique for ELISA procedure. [Nature and Science. 2006;4(2):36-37].

Keywords: assay; enzyme-linked immunosorbent assay (ELISA); protein

1. Introduction

ELISA is the abbreviation of enzyme-linked immunosorbent assay. It is a useful and powerful method in estimating ng/ml to pg/ml ordered materials in the solution, such as serum, urine, sperm and culture supernatant (Savage, 1998). ELISA has been widely used in the life science researches (Ma, 1994; 2004).

The basic principle of an ELISA is to use an enzyme to detect the binding of antigen (Ag) antibody (Ab). The enzyme converts a colorless substrate (chromogen) to a colored product, indicating the presence of Ag:Ab binding. An ELISA can be used to detect either the presence of Ags or Abs in a sample, depending on how the test is designed.

2. Materials and Methods

Homogenize tissue with 5 times of protein extract buffer → centrifuge 10,000 rpm 20 minutes → 0.1 ml supernatant each well → over night at 4°C → PBS with 0.5% BSA washing 3 X 3 minutes → 0.1 ml diluted primary antibody 1-2 hour at room temperature → PBS washing 3 X 3 minutes → 0.1 ml diluted secondary antibody 1-2 hour at room temperature → PBS washing 3 X 3 minutes → dye (0.2 ml pNPP) → 0.05 ml 3 N NaOH → O.D. (405 nm) measurement.

2.1 Extract buffer:

50 mM Tris-HCl or 50 mM HEPES (pH 7.4)
150 mM NaCl
0.02% sodium azide
0.1% SDS
0.1 mg/ml phenylmethylsulfonyl fluoride (PMSF)
0.001 mg/ml aprotinin
1% Nonidet P-40 (NP-40) or 1% Triton X-100
(The half-life of a 0.02 mM aqueous solution of PMSF is about 35 minutes. PMSF is usually stored as a 10 mM or 100 mM stock solution 1.74 or 17.4 mg/ml in isopropanol at -20°C).

2.2 Homogenize sample under ice.

2.3 Centrifuge sample at 10,000 rpm for 20 minutes at 4°C.

2.4 Keep supernatant at -70°C until usage.

2.5 **PBS:** Phosphate-buffered saline (PBS), pH 7.4, 1000 ml (NaCl 8 g, KCl 0.2 g, Na₂HPO₄ 1.44 g, KH₂PO₄ 0.24 g, adjust to pH 7.4 with HCl). Add 0.5% BSA of 1% milk into PBS when washing processed. It can also use Dulbecco's PBS or try others. Instead of BSA, it can use gelatin or milk. Skim (0.5% to 1%) milk could reduce the non-specific reaction.

2.6 **Antibody:** Primary and secondary antibodies are normally 1:1000 to 1:2000 diluted by PBS and 0.1 ml each well.

2.7 **Dye:** Use alkaline phosphatase yellow (pNPP) liquid substrate as the dye for the ELISA (Derango et al. 1996). This product is supplied as a ready-to-use buffered alkaline phosphatase substrate p-nitrophenylphosphate (pNPP). Prior to reaction with alkaline phosphatase, the substrate should appear as a colorless to pale yellow solution. It will develop a yellow reaction product when reacted with phosphatase in microwell applications. For the end-point assays, the reaction can be stopped with 0.05 ml/well of 3 N NaOH for every 0.2 ml of substrate reaction. Following the reaction with alkaline phosphatase, a yellow reaction product forms can be read at 405 nm.

3. More Information

3.1 Using Polyclonal Antibodies:

- (1) Antibody purification: Protein G column is the best for this purpose.
- (2) Conjugate: Making conjugate is the most important part (e.g. horseradish peroxidase).
- (3) 96-well plate: Making the solid phase using the 96-well plate.

3.2 Buffers and other reagents:

- (1) Plate buffer: 0.1 M Sodium carbonate buffer, pH 9.5.
- (2) Reaction buffer: 0.01 M Sodium phosphate buffer, pH 7.2, 0.15 M NaCl (PBS), 0.5% BSA, 0.05% thimerosal; You can also use Dulbecco's PBS or try others. Instead of BSA, you can use gelatin. Skim

(0.5% to 1%) milk could reduce the non-specific reaction.

- (3) Washing buffer: 0.05% Tween-20, 0.01 M Sodium phosphate buffer, pH 7.2 or 0.05% Tween-20, 0.15 M NaCl.
- (4) Developing buffer: 0.05 M Sodium acetate buffer, pH 5.5.
- (5) TMB stock solution: Tetramethylbenzidine 1 mg/ml in DMSO.

3.3 Making Conjugate:

- (1) Nakane's method.
- (2) Glutaraldehyde method.
- (3) Maleimide method.

3.4 Steps:

- (1) 2 mg Horseradish peroxidase (HRP) in 1 ml water: A.
- (2) 21.4 mg NaIO₄ (never to be NaIO₃) in 1 ml water: B.
- (3) 100 micro-l of B into A: Color will change to the dark green!
- (4) Wait for 10 min at room temperature.
- (5) Put into the dialysis tube (such as Molecular cut off 20,000).
- (6) F. Put the tube into 5 mM NaAcetate buffer, pH 4.0 in a 2 to 3 l flask.
- (7) Dialysis overnight: Color will change to the gold.
- (8) Raise the pH of the HRP solution to pH = 9.0 by the addition of 0.2 M NaCarbonate buffer, pH 9.5 (try an aliquot of 0.05 ml).
- (9) Mix with the antibody solution (8 mg of IgG in 1 ml), which has been pre-dialyzed to 0.01 M NaCarbonate buffer, pH 9.0 overnight.
- (10) Incubate the mixture for 2 hr at room temperature.
- (11) Put freshly prepared 0.1 ml, 0.1 M NaHBr₄ in water to the solution.
- (12) Incubate at 4 degree for 2 hr.
- (13) Put the mixture into a dialysis tube and dialyze against PBS overnight.
- (14) Now the conjugate solution is ready for use. Add thimerosal to a final concentration of 0.02% for preservation. Add glycerol to a final concentration of 10% (optional). If you stock the conjugate solution for a long period such as years, stock it at -80 degree. But, in this case, don't repeat freeze-thaw. You can stock the solution at 4 degree at least 6 months.

3.5 Preparation of ELISA Plate: This will take 2 hr to overnight. Overnight is preferable.

- (1) Dilute antibody (IgG) by Plate buffer: 5 to 10 micro-g/ml.
- (2) Put the diluted antibody solution, 0.1 ml to the wells of 96-well ELISA plate.

- (3) Incubate for 2 hr at room temperature or overnight at 4 degree.
- (4) Discard the solution and wash the plate three times by washing buffer. Put 200 micro-l into wells using micro-pipette or just put the Washing buffer using some devices.
- (5) Discard the Washing buffer by tapping against paper towel.
- (6) Put 0.15 to 0.2 ml of reaction buffer. Now, the plate is ready for use. You can stock the plate at least for 6 months. Take care not to dry up the plate.

3.6 Using Monoclonal Antibodies:

- (1) Antibody purification: Antibody purification step is the only special part comparing with materials and methods in using polyclonal antibody. For most monoclonals, except for IgM, Protein G column will be good for the practical use. If you failed by this method, confirm your procedure again before proceeding to the other methods such as DEAE column. When your monoclonal antibody is IgM, try Protamine column combined with molecular sieving column. Others are the same as above mentioned in "Using polyclonal antibodies."
- (2) Try skim milk (any kind of powdered milk such as powdered milk for babies) instead of BSA: It's really cheap! Try 1% to 3%. It will decrease the background!! Thing is stability. It will form precipitate if you keep it for a few months. If you are running many plates, it is good alternative.

Correspondence to:

Hongbao Ma
138 Service Road
B410 Clinical Center
Michigan State University
East Lansing, MI 48824
Telephone: 517-432-0623
Email: hongbao@msu.edu

References

1. Derango R, Page J. The quantitation of coupled bead antibody by enzyme-linked immunosorbent assay. *J Immunoassay* 1996;17:145-53.
2. Hongbao Ma. The Structure and Function of Metallothionein. Ph.D. Dissertation of Peking University. 1994:37-46.
3. Hongbao Ma, Kate Claycombe, Ruiping Huang, George S. Abela. C-reactive protein rise is associated with the development of acute events in a model of plaque rupture and thrombosis. *FASEB Journal* 2004;18(8):C193-194.
4. Savige JA, Paspaliaris B, Silvestrini R, Davies D, Nikoloutsopoulos T, Sturgess A, Neil J, Pollock W, Dunster K, Hendle M. A review of immunofluorescent patterns associated with antineutrophil cytoplasmic antibodies (ANCA) and their differentiation from other antibodies. *J Clin Pathol* 1998;51:568-75.

Torque Teno Virus (TTV) Infection In Egyptian Patients with Chronic Liver Disease and Hepatocellular Carcinoma

Maisa Omar¹, Nevine Fam¹, Samah Saad El-Din¹, Mahmoud Romeih², Hanem Mohamed², Moatez Hassan³, Ibrahim Mostafa³, Afkar Badawy⁴, Maha Akl⁴, Mohamed Saber².

Microbiology¹, Biochemistry², Tropical Medicine³ and Pathology⁴ Departments, Theodor Bilharz Research Institute (TBRI), Guiza 12411, Egypt

** , presently at 413 Biochemistry and Molecular Biology Department, Michigan State University, East Lansing, MI 48824, USA. Email: romeih@msu.edu

* , presently at Food Science and Human Nutrition, Michigan State University, East Lansing, MI 48824, USA. Email: ahmedha@msu.edu

Abstract: TTV has been recently identified as a causative agent of non-A to non-G hepatitis. However, the exact role of this virus in the pathogenesis of chronic liver disease (CLD) and the development of hepatocellular carcinoma (HCC) remain controversial. To clarify these issues, the prevalence of this virus and its impact on the severity of liver disease and development of HCC among Egyptian patients were assessed. The study was conducted on 84 patients with CLD and 22 with HCC. They were diagnosed by clinical, biochemical, ultrasonographic and histopathologic findings. Chronic liver disease patients were classified into: chronic hepatitis (CH=48), compensated cirrhosis (CC=12) and decompensated cirrhosis (DC=24). Serum samples were collected from all patients and from 80 healthy volunteers as controls. All samples were serologically tested for markers of hepatitis B virus (HBV) and hepatitis C virus (HCV) infection. HBV DNA, HCV RNA and TTV DNA were detected either by nested or RT-PCR assays. HCV serotyping was performed for 60 out of 85 HCV positive samples using an enzyme immunoassay. Among CLD and HCC patients, 85 had chronic HCV, 5 had chronic HBV and 10 had dual HCV and HBV infections. Coinfection with TTV was detected in 27%, 0% and 20% of patients respectively. TTV DNA was detected in 23.8%, 31.8% and 25.0% of CLD, HCC patients and healthy volunteers respectively. The prevalence of TTV infection in CLD and HCC patients did not significantly differ from that of healthy volunteers, however TTV infection was significantly higher among patients with CC (41.7%) compared to those with DC (16.7%) ($P < 0.05$). No significant differences were detected among TTV infected and non-infected patients concerning demographic, clinical and virologic data. Moreover, TTV viraemia was not significantly higher in HCC-positive than in HCC-negative patients. In conclusion, TTV viraemia is a common finding among adult Egyptian patients with CLD, HCC as well as in healthy volunteers. Infection with TTV does not contribute to the severity of liver disease nor to causation of HCC. [Nature and Science. 2006;4(2):38-45].

Keywords: Torque Teno Virus (TTV); Infection; Egyptian; Patients; Liver Disease; Hepatocellular Carcinoma

Abbreviations: CH: Chronic hepatitis; CC: Compensated cirrhosis; DC: Decompensated cirrhosis; HCC: Hepatocellular carcinoma.

1. Introduction

Chronic liver disease and hepatocellular carcinoma constitute a major health problem in Egypt and have been known to be commonly associated with HBV and HCV infections (Darwish *et al.*, 1993; Waked *et al.*, 1995). However, a significant proportion of cases is still of unknown aetiology, indicating the existence of additional causative viral agents (Tangkijvanich *et al.*, 2000).

A novel hepatitis virus candidate designated TTV was recently identified as possible causative agent of human viral hepatitis. It was first identified in a patient with post-transfusion hepatitis of unknown aetiology and named with the initials of the person in whose serum it was first detected (Nishizawa *et al.*, 1997). The virus was characterized as being non-enveloped with

circular, single-stranded DNA (Mushahwar *et al.*, 1999). Due to its genomic structure, the virus was placed tentatively within the *Circoviridae* family (Miyata *et al.*, 1999) or in a novel virus family; the *Circinoviridae* (Mushahwar, 2000) or the *Paracircoviridae* (Takahashi *et al.*, 2000).

TTV has an extremely wide range of sequence divergence for a DNA virus, and it has been proposed that it exists as a swarm of closely related but different viral species (Khudyakov *et al.*, 2000). Five major phylogenetic groups including at least 23 genotypes have been identified (Peng *et al.*, 2002). Multiple infection with different TTV genotypes has been detected in humans and evidence for TTV evolution in patients with persistent infection has also been recognized (Irving *et al.*, 1999; Takayama *et al.*, 1999).

TTV is widely distributed throughout the world (Abe *et al.*, 1999). Both acute resolving and chronic persistent hepatitis infection have been identified among TTV-infected humans (Luo *et al.*, 2002). Furthermore, TTV has been detected in a variety of liver disease including non A-G post-transfusion hepatitis, fulminant hepatic failure, chronic persistent hepatitis, cryptogenic liver disease and hepatocellular carcinoma (Charlton *et al.*, 1998; Okamoto *et al.*, 1998; Yamamoto *et al.*, 1998; Orii *et al.*, 1999). Evidence of potential hepatotropism of TTV was reported with TTV DNA titres shown to be 10-100 folds greater in liver tissue than in serum (Okamoto *et al.*, 1998).

The significance and interaction of TTV with other hepatitis viruses remain controversial. Several studies on HCV patients coinfecting with TTV suggested that the association of both viruses increased severity of liver damage (Okamoto *et al.*, 1998; Zein *et al.*, 1999). Other studies found no such correlation and reported that the dynamics of ALT were unrelated to TTV viraemia (Gimenez-Barcons *et al.*, 1999; Irving *et al.*, 1999). However, it has been recently reported that TTV viral load was independently associated with HCC among patients with HCV infection (Tokita *et al.*, 2002). The levels of TTV vary in patients co-infected with other viruses and there has been considerable speculation as to whether TTV contributes to pathogenesis by other viruses or if the varying levels might be related to immune activation in the host (Fabrizio *et al.*, 2005).

Despite the worldwide distribution and intensive studies of TTV, the association of this virus with liver disease is still questionable. Its effect on severity of liver disease, aggravation of disease condition and progress to complications as cirrhosis and HCC has not yet been clearly defined. The aim of the present study was to assess the prevalence of TTV infection among Egyptian patients with CLD and HCC compared with healthy volunteers. The impact of this virus on the severity of liver disease and its association with the development of HCC were also investigated.

2. Patients and Methods

2.1. Patients

The present study was conducted on 84 patients with CLD and 22 with HCC who were examined and followed up at Theodore Bilharz Research Institute inpatient clinic between August 2001 and September 2003. Patients were diagnosed as CLD cases based on elevated serum ALT and AST for 6 months or longer, ultrasonographic evidence of liver disease or cirrhosis and histopathologic findings indicating the presence of chronic hepatitis or cirrhosis. The diagnosis of HCC was based on histopathology and/or a combination of mass lesions in the liver by

ultrasonographic imaging. Eighty serum samples were collected from healthy volunteers to serve as controls.

2.2. Methods

Patients' characteristics, personal history and clinical examination with special stress on manifestations of liver disease and decompensation were recorded. Patients were also examined by ultrasonography and upper endoscopy. Liver biopsy was done when indicated for 50 patients and diagnosed histopathologically. Blood samples were collected and subjected to complete blood picture and liver function tests (serum bilirubin, ALT, AST, alkaline phosphatase, albumin, globulins, prothrombin time and concentration) and alpha-feto protein. Serum samples were stored in several aliquots at -70°C until tested for viral markers of HBV, HCV, and PCR for HCV RNA, HBV DNA and TTV DNA.

Based on clinical, laboratory, ultrasonographic and histopathologic diagnosis, CLD cases were classified into: chronic hepatitis (CH=48), compensated cirrhosis (CC=12) and decompensated cirrhosis (DC=24). Decompensated cirrhosis was defined as the presence of complications related to portal hypertension such as ascites, encephalopathy, decreased hepatic synthetic function reflected by decreased albumin concentration and prolonged prothrombin time.

According to virological features, our patients were diagnosed as chronic HCV or chronic HBV or non-B non-C hepatitis on the basis of HCV antibody, HCV RNA, HBsAg, HBcAb and HBV DNA testing.

2.4. Serologic Assays

Serum HBsAg and HBcAb were measured using enzyme immunoassay kits (EIA Dia-Sorin, Italy). HCV antibody was detected using third generation EIA kit (Murex-Biotech Ltd., UK).

2.5. HCV Serotyping

Serotyping (1-6) of HCV positive samples was performed using rapid EIA (Murex-Biotech Ltd., UK). Typable results were recorded according to pattern of response and interpreted as single or mixed serotype.

2.5. Detection of HCV RNA by Nested RT-PCR

RNA extraction was performed by the acid guanidinium thiocyanate and phenol-chloroform single-step method (Chomczynski and Sacchi, 1987). HCV RNA was detected by qualitative nested RT-PCR using 2 sets of primers within the 5' non-coding region (Van Doorn 1994). The PCR products were analyzed using 2% agarose gel electrophoresis.

2.6. Detection of HBV DNA by Nested PCR

HBV genomic DNA was extracted from serum using guanidinium isothiocyanate phenol chloroform

method and dissolved in EDTA. HBV DNA was detected by nested PCR using a set of primers designed for the core/precore region. Amplification products (approximately 0.23 kb band) were visualized using 1.5% agarose gel electrophoresis. The detection limit of this system was 200 DNA copies/reaction (Saber et al., 1996).

2.7. Detection of TT Virus DNA by Nested PCR

DNA was extracted from 100 µL serum by serum by guanidinium isothiocyanate phenol chloroform method and dissolved in EDTA (Saber et al., 1996). Nested PCR was performed according to Takahashi *et al.*, (1998a). Thermal cycler was programmed first to preheat the sample at 95°C for 10 min to activate Taq

DNA polymerase. Samples were then subjected to 55 cycles of 94°C for 20s and 72°C for 30s and finally one cycle at 72°C for 10 min using Perkin Elmer, Norwalk, C.T. thermal cycler. The sequences of TT virus-specific primers were: 5'-GCT ACG TCA CTA ACC ACG-3' (T801, sense primer, nucleotides 6 to 25) and 5'-CTB CGC TGT GTA AAC TCA CC-3' (T 935, antisense primer, nucleotide 185 to 204, B=G, C, or T) as designed by Takahashi *et al.*, (1998a), in the 5'-end region of the TA278 isolate.

2.8. Statistical analysis

Test of proportion and Chi square analysis were used for statistical analysis as appropriate. P value <0.05 was considered significant.

Table 1. Prevalence of TTV infection among patients coinfecting with other hepatitis viruses

Group(n)	TTV +ve	
	n	%
HCV (85)	23	27.0
HBV (5)	0	0
HCV+HBV (10)	2	20.0
Non B non C (6)	2	33.3

Table 2. Prevalence of TTV DNA among the different studied groups

Group (n)	TTV +ve	
	n	%
CLD (84)	20	23.8
HCC (22)	7	31.8
Healthy volunteers (80)	20	25.0

CLD: Chronic liver disease.

HCC: Hepatocellular carcinoma.

Table 3. Prevalence of TTV infection among different studied patients according to the severity of liver disease

Stage of Liver Disease (n)	TTV +ve	
	n	%
CH (48)	11	23.0
CC (12)	5	41.7*
DC (24)	4	16.7
HCC (22)	7	31.8

CH: Chronic hepatitis.

CC: Compensated cirrhosis.

DC: Decompensated cirrhosis

HCC: Hepatocellular carcinoma.

* P value <0.05 relative to DC group.

Table 4. Demographic, virological and clinical data of patients with chronic liver disease and hepatocellular carcinoma relative to TTV DNA viraemia

Characteristic	TTV +ve (n=27)		TTV -ve (n=79)		P value
	n	%	n	%	
Age (mean±SD)	42.22±9.22		43.56±10.8		NS
Sex (M:F)	20:7		60:19		NS
Mean ALT level (IU/L)	53±12		62±32		NS
Virological features					
HBV markers +ve	0	0%	5	6.3%	NS
HCV markers +ve	23	85.2%	62	78.5%	NS
HBV and HCV +ve	2	7.4%	8	10.1%	NS
HBV and HCV -ve	2	7.4%	4	5.1%	NS
Disease categories					
Chronic hepatitis	11	40.7%	37	46.8%	NS
Compensated cirrhosis	5	18.5%	7	8.9%	NS
Decompenstated cirrhosis	4	14.8%	20	25.3%	NS
Hepatocellular carcinoma	7	25.9%	15	19.0%	NS

Table 5. Analysis of features of HCC among 85 patients with HCV-related liver disease

Features	Patients with HCV-related liver disease				P value
	With HCC (n=22)		Without HCC (n=63)		
Age (mean±SD)	50±6.2		43±6.2		0.05
Sex (M:F)	15:7		44:19		
Liver cirrhosis	17	77.3%	31	49.2%	0.01
Anti-HCV +ve	22	100.0%	41	65.0%	0.001
HCV RNA +ve	17	77.3%	28	44.4%	0.01
TTV DNA +ve	7	31.8%	18	28.5%	NS

Table 6. Distribution of HCV serotypes in 60 patients with chronic HCV relative to TTV viraemia

HCV Serotype (n)	TTV +ve	
	n	%
Type 4 (42)	21	50*
Mixed (14) (1+4 or 2+4 or 4+5)	2	14.2
Other serotypes (4) (1 or 3)	--	--

- P value <0.01 relative to mixed group.

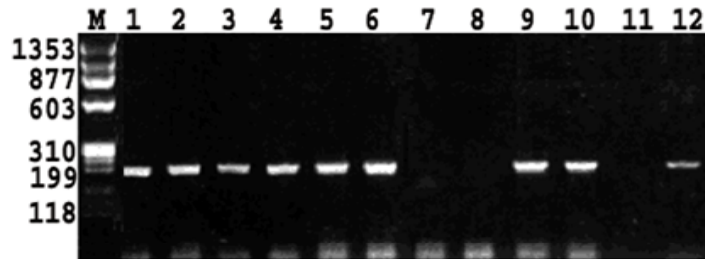

Figure 1. Detection of TTV-DNA by nested PCR. PCR products were separated on 1.5% agarose gel electrophoresis and were stained with ethidium bromide . Lanes 1,2,4,3,4,5,6,9,12, show positive TTV DNA viraemia at 199 bp. Lane 7,8 Negative TTV-DNA. Lane 10,11 positive and negative control respectively.

3. Results

Virologic marker testing of the patient groups showed that 85 had chronic HCV, 5 had chronic HBV, 10 had dual HCV and HBV infections and only 6 patients had non-B non-C. Coinfection with TTV was detected in 27.0%, 0%, 20.0% and 33.3% of patients respectively (Table 1).

TTV DNA was found in 23.8%, 31.8% and 25.0% of patients with CLD, HCC and healthy volunteers, respectively. Although a high prevalence of TTV viraemia was detected among all patient groups compared with the controls, no significant differences were observed (Table 2).

Positive results of nested PCR test for detection of TTV DNA are shown in Figure 1. The prevalence of TTV infection in relation to the severity of liver disease is shown in table 3. TTV infection was significantly higher (41.7%) among patients with CC compared to those with DC (16.7%) (P value <0.05).

Demographic, virologic and clinical data were compared according to the status of TTV infection in patients with CLD and HCC (Table 4). There were no significant differences between TTV-infected and non-infected patients regarding mean age, sex distribution, ALT serum levels, virologic features of HBV and HCV or category of liver disease. Histopathologic examination of the 50 cases in which liver biopsy was done revealed no variation in necro-inflammatory activity or fibrotic stage between cases between cases of dual TTV and HCV infections compared to isolated HCV infection.

Analysis of features of HCC among 85 patients with chronic HCV-related disease showed that HCC was significantly associated with higher age (P<0.05), liver cirrhosis (P<0.01) and HCV RNA positivity (P<0.01). TTV viraemia was not significantly higher in HCC-positive than in HCC-negative patients (Table 5).

HCV serotyping was done in 60 of 85 (70%) of samples. Serotype 4 was detected in 42 (70%), mixed serotypes (1+4 or 2+4 or 4+5) were detected in 14 (23.3%), other serotypes (1 or 3) were detected in 4 (6.7%) of those samples. TTV infection was significantly associated with HCV serotype 4 (50%) compared to patients infected with mixed serotypes (14.2%) (P<0.01) (Table 6).

4. Discussion

Knowledge about novel hepatotropic virus TTV is growing fast, but some fundamental aspects remain to be elucidated. Its prevalence and clinical significance are being assessed worldwide, however its relationship with aggravation and progression to severe liver disease and HCC remain controversial (Tangijvanich et al., 2003; Tokita et al., 2002).

The present study attempted to clarify these issues in Egypt, a country known for its high endemicity of

liver disease and hepatotropic viruses (El-Gohary et al., 1995; Arthur et al., 1997).

The prevalence rates of TTV DNA in the sera of normal healthy persons were found to vary widely in different countries with a high frequency of viraemia in adults (Bendinelli et al., 2001). In the present study, the prevalence of TTV infection among Egyptian healthy volunteers was high (25%). This prevalence was higher than that detected in western population (1-13%) (Abe et al., 1999; Gallian et al., 2000), but lower than that found in Asian countries as Japan (92%), Thailand (62%), Korea (53%) and among nationals and non-nationals in United Arab Emirates (35% and 89% respectively) (Kato et al., 1999; Kobayashi et al., 1999; Nakano et al., 1999; Al-Moslih et al., 2004).

In the present study, the prevalence of TTV viraemia among Egyptian patients with CLD and HCC was not significantly higher than that found in healthy volunteers. This was consistent with other studies reporting that TTV viraemia was prevalent among patients with CLD, whether viral or cryptogenic, at similar rates to control groups with no liver disease (Gad et al., 2000; Berg et al., 1999; Nakano et al., 1999).

In contrast, the prevalence of TTV in patients with CLD from USA and Europe was significantly higher than that in blood donors (50-72.5% versus 1-13%) (Maggi et al., 1999; Mizokami et al., 2000). The difference in prevalence of TTV DNA carrier state found in our study compared to others may be attributed to the population density, lifestyle, standard of living and mode of transmission of the virus. It has been proved that TTV is not only parenterally transmitted but is also transmitted by faeco-oral route, saliva, breast milk and transplacentally (Inami et al., 2000; Lin et al., 2000; Schröter et al., 2000; Bendinelli et al., 2001). Moreover, the ubiquitous nature of the virus raises the speculation whether the virus is pathogenic, opportunistic, a cofactor of other infections or a modulator of immunity that can promote other microbes to be infectious (Maggi et al., 2003). The variability in prevalence of TTV in different studies may be also attributed to the extreme heterogeneity of its genome making detection dependent on the viral DNA segment targeted for amplification. This has an enormous impact on PCR sensitivity, the only available method for detection of the virus (Takahashi et al., 1998b; Salakova et al., 2004).

In the present study, TTV coinfection with HCV, HBV and dual HCV HBV infections was 27%, 0% and 20% respectively. This was lower than that detected in other studies by Savas et al., (2003) from Turkey (73% with HCV and 91% with HBV) and by Szenborn et al., (2003) from Poland (53.8% with HCV and 47.3% with HBV). The lower prevalence of TTV DNA in our

study may be due to regional differences of TTV genotypes and the variability in the primers used in PCR (Salakova et al., 2004; Itoh et al., 1999; Verdi et al., 2001). One study in Turkey detected TTV infection in 34% and 6% with two different primer sets in the same 50 chronic HBV patients, while the infection rate in 150 healthy blood donors was 40% and 8 % respectively (Verdi et al., 2001). Moreover, in our study estimation of TTV prevalence in the HBV patients cannot be judged due to the small number of patients identified with HBV markers.

A single infection with TTV in the absence of HCV or HBV infection is uncommon in patients with CLD (Abraham et al., 2003). In the present study, TTV was detected in 2 of 6 patients who had no viral markers for HBV or HCV and their ALT levels did not differ from TTV-negative patients of the same group. This is in accordance with Fiordalisi et al. (1996) who reported that the presence of TTV DNA in sera of patients with CLD of unknown aetiology does not prove a causal relation of liver disease. Also, Itoh et al., (1999) suggested that TTV of restricted genotypes may be associated with liver disease. 1- HBV and HCV are major causes of CLD and cirrhosis which may ultimately lead to liver transplantation. Identification of factors that modulate the progression of liver disease is therefore potentially of great importance. Our results showed that TTV did not appear to aggravate the severity of liver disease among Egyptian patients with CLD resulting from HBV and/or HCV infections. Analysis of TTV-positive versus negative cases showed no association between the presence of this virus and severity of liver disease in terms of serum ALT levels, ultrasonographic and histopathology findings. These data agree with the reports of other investigators (Nakano et al., 1999; Maggi et al., 2003; Salakova et al., 2004; Maggi et al. 2003). Moreover, our finding that TTV viraemia was significantly higher in patients with compensated than in those with decompensated cirrhosis may further deny the role of this virus in the advancement of cirrhosis. However, evidence on the non- pathogenic role of TTV in CLD is not totally unequivocal, since data from other reports support a possible role of TTV in development of severe liver disease (El-Gohary et al., 1995). Several studies on HCV patients, coinfecting with TTV appeared to be associated with increased severity of biochemical and histologic parameters of liver diseases (Yamamoto, et al., 1998; Abraham et al., 2003; Fiordalisi et al., 1996). Also, the ability of TTV to replicate in the liver makes it likely that TTV may cause occasional liver damage (Tuveri et al., 2000). Many speculations regarding the conditions upon which TTV can produce liver damage have been suggested. First, TTV might cause disease only when activated by superinfection with other viruses Van Doorn (1994). Second, liver damage might

become evident only when virus replication is above a certain threshold. Third, certain TTV types or variants might be especially hepatopathogenic Okamoto et al., (1999). 2- The high prevalence of TTV in general population, may complicate linking TTV to hepatic disease and other pathologic states Maggi et al. (2003). This unusual feature among viruses aroused the proposal that TTV might be a commensal virus or part of human microflora Simmonds P (2002). Another major complication is the extreme heterogeneity of TTV genome, its divergent genogroups (1-5), and genotypes (23) each of which possesses distinct biologic properties and pathogenic potentials Peng et al. (2002); Maggi et al. (2003).

The development of HCC is a major problem in chronic HCV infection, and persistent infection has proved to be an independent risk factor for HCC development in Egyptian population Hassan et al. (2001). Other risk factors for HCC development in HCV-related CLD have been reported as HBV or HIV infection, heavy alcohol intake and liver cirrhosis Colombo M (1999). Moreover, Tokita et al. (2002) suggested that a high TTV viral load is an independent factor associated with occurrence of HCC in HCV patients. The high prevalence of TTV infection in patients with HCC found in this study as well as other studies (Nakagawa et al., 1999; Tagger et al., 1999; Pineau et al., 2000; Hassabo et al., 2003) is intriguing. This may suggest a potential pathogenic association between TTV and HCC in HCV-related disease. However, as we could not detect a significant difference in terms of TTV prevalence among HCC- positive and negative cases; nor in terms of HCC prevalence among TTV-positive and negative persons. Therefore, TTV might be a coincidental agent rather than a cause in the development of HCC.

A possible explanation for the high prevalence of TTV viraemia with HCC may be related to the immunosuppressed status in these patients. Another explanation is the higher exposure rate of HCC patients to TTV. Those patients are more likely to have undergone multiple medical or radiological interventions such as paracentesis or angiography which may be associated with increased risk of exposure (Zein et al, 1999).

In conclusion, the results of the study indicate that TTV is commonly present in adult patients with CLD and HCC as well as in healthy volunteers at comparable rates. It seems that the infection does not contribute to the severity of liver disease nor in causation of HCC.

Attempts to correlate TTV with liver disease need further studies that deal with viral load quantification, genetic characterization and detection of the virus in liver tissue.

5. Acknowledgement:

This work was funded by Hepatitis Research Project number 74D of Microbiology Department, Theodor Bilharz Research Institute (TBRI).

6. References

1. Abe K, Inami T, Asano K, et al. (1999): TT virus infection is widespread in general populations from different geographic regions. *J Clin Microbiol*, 37: 2703-2707.
2. Abraham P, John GT, Raghuraman S, et al. (2003): GB virus C/hepatitis G virus and TTV infections among high risk renal transplant recipients in India. *J Clin Virol*, 28: 59-69.
3. Al-Moslih MI, Abuodeh RO and Hu YW (2004): Detection and genotyping of TT virus in healthy and subjects with HBV or HCV in different populations in the United Arab Emirates. *J Med Virol*, 72: 502-508.
4. Arthur RR, Hassan NF, Abdallah MY, et al. (1997): Hepatitis C antibody prevalence in blood donors in different governorates in Egypt. *Trans R Soc Trop Med Hyg*, 9: 271-274.
5. Bendinelli M, Pistello M, Maggi F, et al. (2001): Molecular properties, biology, and clinical implications of TT virus, a recently identified wide spread infectious agent of humans. *Clin Microbiol Rev*, 14: 98-113.
6. Berg T, Schriber E, Heuft HG, et al. (1999): Occurrence of a novel DNA virus (TTV) infection in patients with liver diseases and its frequency in blood donors. *J Med Virol*, 59: 117-121.
7. Charlton M, Adjei P, Poterucha J, et al. (1998): TT-virus infection in North American blood donors, patients with fulminant hepatic failure, and cryptogenic cirrhosis. *Hepatology*, 28: 839-842.
8. Chomczynski P and Sacchi N (1987): Single step method of RNA isolation by acid guanidine thiocyanate-phenol-chloroform extraction. *Anal Biochem*, 162: 156-160.
9. Colombo M (1999): Natural history and pathogenesis of hepatitis C virus related hepatocellular carcinoma. *J Hepatol*, 31: 25-30.
10. Darwish MH, Issa SA, Aziz AM, et al. (1993): Hepatitis C and B viruses and their association with hepatocellular carcinoma in Egypt. *J Egypt Public Health Assoc*, 68: 1-9.
11. Desai MM, Pal RB, Banker DD (2005): Molecular epidemiology and clinical implications of TT virus (TTV) infection in Indian subjects. *J Clin Gastroenterol*, 39: 422-429.
12. Cheng JD, Hada T, Liu WD, et al. (2000): Investigation of TTV by in situ hybridization in patients with chronic hepatitis. *Hepatol Res*, 18: 43-53.
13. El-Gohary A, Hassan A, Nooman Z, et al. (1995): High prevalence of hepatitis C virus among urban and rural population group in Egypt. *Acta Tropica*, 59: 155-161.
14. Fiordalisi G, Zanella I, Mantero G, et al. (1996): High prevalence of GB virus C infection in a group of Italian patients with hepatitis of unknown etiology. *J Infect Dis*, 174: 181-183.
15. Gad A, Tanaka E, Orii K, et al. (2000): Clinical significance of TT virus infection in patients with chronic liver disease and volunteer blood donors in Egypt. *J Med Virol*, 60: 177-181.
16. Gallian P, Biagini P, Zhong S, et al. (2000): TT virus: A study of molecular epidemiology and transmission of genotypes 1, 2 and 3. *J Clin Virol*, 17: 43-49.
17. Hassabo H, Mahmoud M, Fahmy H, et al. (2003): TT virus among Egyptian patients with hepatocellular carcinoma. *Egypt J Immunol*, 10: 9-16.
18. Hassan MM, Zaghlool AS, El-Serag HB, et al. (2001): The role of hepatitis C in hepatocellular carcinoma. *J Clin Gastroenterol*, 33: 123-126.
19. Inami T, Konomi N, Arakawa Y, et al. (2000): High prevalence of TT virus DNA in human saliva and semen. *J Clin Microbiol*, 38: 2407-2408.
20. Irving WL, Ball JK, Berridge S, et al. (1999): TT virus infection in patients with hepatitis C: Frequency, persistence and sequence heterogeneity. *J Infect Dis*, 180: 27-34.
21. Itoh K, Takahashi M, Ukita M, Nishizawa T, (1999): Influence of primers on the detection of TTV DNA by Polymerase Chain Reaction. *JID* 180: 1750-1751.
22. Kato T, Mizokami M, Orito E, et al. (1999): High prevalence of TT virus infection in Japanese patients with liver disease and in blood donors. *J Hepatol*, 31: 221-227.
23. Khudyakov YE, Cong ME, Nichols B, et al. (2000): Sequence heterogeneity of TT virus and closely related viruses. *J Virol*, 74: 2990-3000.
24. Kobayashi M, Chayama K, Arase Y, et al. (1999): Prevalence of TT virus before and after blood transfusion in patients with chronic liver disease treated surgically for hepatocellular carcinoma. *J Gastroenterol Hepatol*, 14: 358-363.
25. Lin L, Kyono W, Tongson J, et al. (2000): Fecal excretion of a novel human circovirus, TT virus in healthy children. *Clin Diag Lab Immunol*, 7: 960-963.
26. Luo K, He H, Zhang L, et al. (2002): Novel variants related to TT virus distributed widely in China. *J Med Virol*, 67: 118-126.
27. Maggi F, Fornal C, Morrica A, et al. (1999): High prevalence of TTV virus viremia in Italian patients, regardless of age, clinical diagnosis and previous interferon treatment. *J Infect Dis*, 180: 838-842.
28. Maggi F, Marchi S, Fornai C, et al. (2003): Relationship of TT virus and *Helicobacter pylori* infection in gastric tissues of patients with gastritis. *J Med Virol*, 71: 160-165.
29. Miyata H, Tsunoda H, Kazi A, et al. (1999): Identification of a novel GC-rich 113-nucleotide region to complete the circular, single-stranded DNA genome of TT virus, the first human circovirus. *J Virol*, 73: 3582-3586.
30. Mizokami M, Albrecht J, Kato T, et al. (2000): TT virus infection in patients with chronic hepatitis C virus infection: effect of primers, prevalence and clinical significance. *J Hepatol*, 32: 339-343.
31. Moriyama M, Longren W, Zi-Yi Z et al. (2003): TT virus infection does not affect the clinical profiles of patients with hepatitis B and C in Yanbian City, China. *Intervirol* 46: 214-221.
32. Mushahwar IK (2000): Recently discovered blood-borne viruses: Are they hepatitis viruses or merely endosymbionts? *J Med Virol*, 62: 399-404.
33. Mushahwar IK, Erker JE, Muerhoff AS, et al. (1999): Molecular and biophysical characterization of TT virus: Evidence for a new virus family infecting humans. *Proc Natl Acad Sci USA*, 96: 3177-3182.
34. Nakagawa N, Ikoma J, Ishihara T, et al. (1999): High prevalence of transfusion-transmitted virus among patients with non-B, non-C hepatocellular carcinoma. *Cancer*, 86: 1437-1440.
35. Nakano T, Park Y, Mizokami M, et al. (1999): TT virus infection among blood donors and patients with non-B, non-C liver disease in Korea. *J Hepatol*, 30: 389-393.
36. Nishizawa T, Okamoto H, Konishi K, et al. (1997): A novel DNA virus (TTV) associated with elevated transaminase levels in post transfusion hepatitis of unknown etiology. *Biochem Biophys Res Commun*, 241: 92-97.
37. Okamoto H, Nishizawa T and Ukita M (1999): A novel unenveloped DNA virus (TT virus) associated with acute and chronic non-A to G hepatitis. *Intervirol*, 42: 196-204. Simmonds P (2002): TT virus infection: A novel virus-host relationship. *J Med Microbiol*, 51: 455-458.
38. Okamoto H, Nishizawa T, Kato N, et al. (1998): Molecular cloning and characterization of a novel DNA virus (TTV) associated with post transfusion hepatitis of unknown etiology. *Hepatol Res*, 10: 1-16.
39. Orii K, Tanaka K, Umemura T, et al. (1999): Prevalence and disease association of TT virus infection in Japanese patients with viral hepatitis. *Hepatol Res*, 14: 161-170.
40. Peng YH, Nishizawa T, Takahashi M, et al. (2002): Analysis of enteric genomes of thirteen TT virus variants classifiable into the fourth genetic groups, isolated from viremic infants. *Arch Virol*, 147: 21-41.

41. Pineau P, Meddeb M, Raselli R, et al. (2000): Effect of TT virus infection on hepatocellular carcinoma development: Results of a Euro- Asian survey. *J Infect Dis*, 181: 1138-1142.
42. Pistello M, Morrica A, Maggi F, et al. (2001): TT virus levels in the plasma of infected individuals with different hepatic and extrahepatic pathologies. *J Med Virol*, 63:189-195.
43. Saber MA, Badawi H, Abu Aitta A, et al. (1996): Comparative studies in serological diagnosis of hepatitis B (HBV) infection. The role of serum HBV-DNA assessment. *J Egypt Med Assoc*, 79: 92-99.
44. Salakova M, Nemecek V, Konig J, et al. (2004): The epidemiology and phylogeny of TT virus in the Czech Republic. 14th European Congress of Clinical Microbiology and Infectious Diseases. Prague, Czech Republic, 1-4 May: 156
45. Savas MC, Guney C, Kadayifci A, et al. (2003): High prevalence of transfusion transmitted virus infection in patients with chronic liver diseases in an endemic area of hepatitis B and C virus. *Med Princ Pract*, 12: 176-179.
46. Schröter M, Polywka S, Zllner B, et al. (2000): Detection of TT virus DNA and GB virus type C/hepatitis G virus RNA in serum and breast milk: Determination of mother-to-child transmission. *J Clin Microbiol*, 38: 745-747.
47. Szenborn L, Hoehne M, Zalewska I, et al. (2003): Detection of TT virus (TTV) in children and youth with chronic viral hepatitis B and C. *Med Sci Monit*, 9: 29-33.
48. Tagger A, Donato F, Ribero ML, et al. (1999): A case-control study on a novel DNA virus (TT virus) infection and hepatocellular carcinoma. The Brescia HCC study. *Hepatology*, 30: 294-299.
49. Takahashi K, Hoshino H, Ohta Y, et al (1998): Very high prevalence of TT virus (TTV) infection in general population in Japan revealed by a new set of PCR primers. *Hepato Res*, 12:233-239.
50. Takahashi K, Hoshino H, Ohta Y, et al. (2000): Identification of a new human DNA virus (TTV-like mini virus, TLMV) intermediately related to TT virus and chicken anaemia virus. *Arch Virol*, 145: 979-993.
51. Takayama S, Yamazaki S, Matsuo S, et al. (1999): Multiple infection of TT virus (TTV) with different genotypes in Japanese hemophiliacs. *Biochem Biophys Res Commun*, 256: 208-211.
52. Tangkijvanich P, Anukulkarnkusol N, Suwangool P, et al. (2000): Clinical characteristics and prognosis of hepatocellular carcinoma: Analysis based on serum alpha-fetoprotein levels. *J Clin Gastroenterol*, 31: 302-308.
53. Tangkijvanich P, Theamboonlers A, Maturapod S, et al. (2003): Sen virus infection in patients with chronic liver disease and hepatocellular carcinoma in Thailand. *J Gastroenterol*, 38: 142-148.
54. Tokita H, Murai S, Kamitsukasa H, et al. (2002): High TT virus load as an independent factor associated with the occurrence of hepatocellular carcinoma among patients with hepatitis C virus-related chronic liver disease. *J Med Virol*, 67: 501-509.
55. Tuveri R, Jaffredo F, Lunel F, et al. (2000): Impact of TT virus infection in acute and chronic, viral-and non viral-related liver diseases. *J Hepatol*, 33: 121-127.
56. Van Doorn LJ (1994): Molecular biology of the hepatitis C virus. *J Med Virol*, 43: 345-356.
57. Verdi H, Uzunlimoglu O, Cagsin S, et al. (2001): Comparison of two different primer sets for PCR detection of transfusion transmitted virus DNA in blood donors, haemodialysis patients, chronic HBV and HCV infection. *J Hepatol* 34 (S1): 163-175.
58. Waked IA, Saleh SM, Moustafa MS, et al. (1995): High prevalence of hepatitis C in Egyptian patients with chronic liver disease. *Gut*, 37:105-107.
59. Yamamoto T, Kajino K, Ogawa M, et al. (1998): Hepatocellular carcinoma infected with the novel TT DNA virus lack viral integration. *Biochem Biophys Res Commun*, 251: 339-343.
60. Zein NN, Arslan M, Li H, et al. (1999): Clinical significance of TT virus infection in patients with chronic hepatitis C. *Am J Gastroenterol*, 94: 3020-3027.

Timed Colored Petri Nets Based Modelling and Scheduling of Aero-engine maintenance

Xinmin Tang, Shisheng Zhong

School of Mechatronics Engineering, Harbin Institute of Technology, Harbin, Heilongjiang 150001, China

txmofhit@hit.edu.cn; zss@hit.edu.cn

Abstract: Aero-engines maintenance procedure can be treated as a typical discrete event dynamic system. A theory that synthesized timed colored Petri net is proposed. The theory adopts a bottom-up approach by merging all sub modules, and each one characterizes the critical resource contention among processes. Nevertheless Petri net seems inapplicable to dynamic scheduling modelling because of its structural rigidity. Shared composition method of Petri net is introduced, which makes its structure adjustable dynamically. Given a set of preemptive dispatching rules, the makespan can be analyzed using linear state equation in the sense of max-plus algebra. To minimize makespan of each aero-engine, genetic algorithm is adopted to arrange the firing sequence of transitions. Dynamic scheduling strategy uses rolling horizon composed by colors is presented. According to the simulation result, the module is verified to be effective and robust. [Nature and Science. 2006;4(2):46-51].

Keywords: timed colored Petri nets; shared composition; static scheduling; dynamic scheduling

1 Introduction

Aero-engine maintenance procedure can be treated as a typical discrete dynamic system (DES). It involves planning, scheduling and controlling of resources, aerial materials, activities, etc. Woxvold proposed a solution to planning and scheduling of aircraft maintenance by combining of MRP (Materials Requirements Planning), PAC (Production Activity Control) and CPM (Critical Path Method) into a unitary structuring technique, which was applied to maintenance of Boeing 737 commercial aircraft[1]. Goldratt used project management technology based on TOC (theory of constraints) to solve maintenance scheduling problem in Israeli air force, which shorten aircraft maintenance duration dramatically by some case studies[2].

In the maintenance work shop, maintenance tasks with different work level may be carried out concurrently, as a result machines resource conflicts are unavoidable. Additionally, maintenance procedures are always interrupted by stochastic events unexpected. Scheduling methods mentioned above do not provide strict mathematical model and are usually applied to static other than dynamic environment. Petri nets as a tool to characterize a concurrent, asynchronous, conflicting, stochastic system is widely used in discrete dynamic system modelling, simulating and scheduling[3]. Timed colored Petri nets is one of high level model which has advantages over basic Petri nets in making the model of a DES much more compact and concise. In this paper, this is gained by introducing "colors" to distinguish among tokens presenting different aero-engines.

The organization of this paper is described as follows. In Sections 2, sub modules based on timed

colored Petri nets describe interactions between components of aero-engine and machine resources are built, and then shared composition method of Petri nets is adopted to realize bottom-up modelling. In Section 3, the makespan of each aero-engine is analyzed using max-plus algebra, then Genetic algorithm is adopted to optimize the firing sequence of transitions during static scheduling. In Section 4, to deal with discrete events emerge in workshop, a dynamic scheduling strategy uses rolling horizon is presented, which made the model more adaptive and robust. In Section 5, an example is demonstrated and the performance is analyzed. Finally, conclusions are provided.

2 Bottom-up Modelling of Aero-engine Maintenance Procedure

2.1 Construction of Sub Modules

Suppose that the directional chart G represents the maintenance workflow of an aero-engine component. Each node of the chart is multivocal, firstly it specifies the maintenance process $w_i \in W$, where W represents all processes of the component, secondly it specifies the machine $m_j \in M$ to process w_i , where M represents all machines. It is assumed that one process only uses one machine and the mapping between W and M is $f: W \mapsto M$. For $w_1(m_1), w_2(m_2) \in W$, if there exists a directional edge, then the component must be transferred to machine m_2 after accomplished processing in machine m_1 .

Definition 1 (*Work Processing Module*). WPM is a state machine $WPM = (P_w, T_w, I_w, O_w, M_{w0})$ and satisfies the following conditions: (1) There exists but only one place $p_{idle} \in P_w$ is called idle place and $M_{w0}(p_{idle}) > 0$.

(2) $\forall p \in (P_W - \{p_{idle}\})$ is called operation place and $M_{W0}(p) = 0$.

The rules to construct *WPM* from *G* are described as follows: (1) Build up one by one mapping from nodes *W* to transitions T_W , $g: W \mapsto T_W$. (2) For $w_u, w_v \in W$, if there exists a directional edge, then add place p_v to P_W , let $I(p_v, t_v) = O(p_v, t_u) = 1$ and $M_{W0}(p_v) = 0$. (3) If in-degree $\text{deg}^+(w_i)$ of $w_i \in W$ is zero, then add idle place p_{idle} to P_W , let $I(p_{idle}, t_i) = 1$ and $M_{W0}(p_{idle}) = 1$.

Definition 2 (Resource Sharing Module). *RSM* is extended from *WPM* and satisfies the following conditions: (1) $\forall p \in P_M$ is called resource place and $|M_{M0}(p)| \geq 1$ represents the quantity of the resource. (2) $\forall t \in T_W$, $\exists p \in P_M$, such that $p \in \bullet t \cap t^\bullet$, where $I_M(p, t) = O_M(p, t) = 1$, which means resources are not exhaustive and should be released after the process is accomplished.

The rules to extend *RSM* from *WPM* are described as follows: (1) $\forall t \in T_W$, Build up one by one mapping from *M* to P_M , $h: M \mapsto P_M$. (2) $\forall p \in P_M$, $\forall t \in T_W$, if $f(g^{-1}(t)) = h^{-1}(p)$, then let $I_M(p, t) = O_M(p, t) = 1$, else let $I_M(p, t) = O_M(p, t) = 0$.

According to definition 2, the resource place looks like "resource dispatching and recycling center". Its initial marking specifies that the resource is available and processes related must compete for the resource[4].

2.2 Extension to Sub Modules

It is obvious that *RSM* reveals the interactions between processes of a single component instance. In order to characterize the resources contention among multiple instances of the component, the original Petri nets should be expanded for more meaningful. An effective resolution is to set up relationship between color set and nodes of Petri nets including places and transitions. Additionally, the deterministic time delay should be related with the transitions of *RSM*.

Definitions 3 (Timed colored resource sharing module). *TCRSM* extended by *RSM* is defined as follows: $TCRSM = (P_W \cup P_M, T, C, I, O, M_0, D)$ is timed colored Petri nets, where P_W are maintenance operation state places, P_M are machine resource places; $T = T_W$ are maintenance processes; C is color function defined from places and transitions into color set, $\forall p_i \in P_W$, $C(p_i) = \{a_{i,1}, \dots, a_{i,u_i}\}$, $u_i = |C(p_i)|$, $\forall p_j \in P_M$, $C(p_j) = \{m_j\}$, $m_j \in M$; $\forall t_i \in T_W$, $C(t_i) = C(p_i) \cup \{m_i\}$; $I: C(p) \times C(t) \mapsto N$ is input function that specifies input place of transition t ; $O: C(t) \times C(p) \mapsto N$ is output function that specifies output place of transition t ; initial marking M_0 is defined from $P_W \cup P_M$ into vector and $M(p)(c)$ represents the token number with a binding color c in the place p ; $D: C(T) \mapsto R^+$ is time delay function specify the firing time duration of transitions.

Transition $t_i \in T$ with a binding color $a_{i,h}$ is said to be firing enable at marking a M if $\forall p \in \bullet t_i$

$M(p)(a_{i,h}) \geq I(a_{i,h}, a_{i,h})$ and $M(p)(m_i) \geq I(m_i, m_i)$, where $m_i \in M$. When enabled transition t_i begins to fire, the new marking is calculated from:

$$\forall p_i \in \bullet t_i: M'(p_i)(c) = M(p_i)(c) - I(c, c), c = \{a_{i,h}, m_i\} \quad (1)$$

Once transition t_i begins firing, it will finish after duration $D(t_i)$. The new marking is calculated from:

$$\forall p_j \in t_i^\bullet: M'(p_j)(c) = M(p_j)(c) + O(c, c), c = \{a_{i,h}, m_i\} \quad (2)$$

The flowing of colored token from place to place represents the components of aero-engine transferring from one machine to another, which reveals' the busy and idle state of machine resources in the discrete time duration. *TCRSM* based on timed colored Petri nets has properties as follows:

Property 1 (Conservation). Note that the *WPM* is a state machine, then $\forall p \in P_W$, such that $|p^\bullet| \leq 1$ and $|p^\bullet| \leq 1$, so $\forall M \in R(M_0)$, such that $\Gamma_{P \rightarrow P_W}(M) = \Gamma_{P \rightarrow P_W}(M_0)$, where $\Gamma_{X \rightarrow Y}(Z)$ represents the projection of Z from X to subset Y . For *RSM*, $\forall p \in P_M: I(p, t) = O(p, t)$, in other words, resource tokens are not exhaustive and can be reusable after released, so $\Gamma_{P \rightarrow P_M}(M) = \Gamma_{P \rightarrow P_M}(M_i)$. Synthetically, there exists vector $\varpi^T = [1, 1, \dots, 1]^T$, such that $\varpi^T M = \varpi^T M_0$, where $M(p_i) = \sum n_{i,h} a_{i,h}$, $n_{i,h} = M(p_i)(a_{i,h})$ is the quantity of token with a binding color $a_{i,h}$. So *TCRSM* is conservative.

Property 2 (Boundedness). Note that *RSM* is conservative, then there exist $\varpi^T M = \varpi^T M_0$, where $\varpi^T = [1, 1, \dots, 1]^T$, that is $\forall p_i \in P_W \cup P_M$, satisfies $\sum_i M(p_i) = \sum_i \sum_h n_{i,h} a_{i,h}$, then $\forall p_i \in P_W \cup P_M: M(p_i) \leq \sum_i \sum_h n_{i,h} a_{i,h}$, so *TCRSM* is bounded.

Property 3 (Deadlock-free). For *RSM*, $\forall p \in P_M$, $\exists t \in T_W$, such that $I_M(p, t) = O_M(p, t)$, that is $\bullet p = p^\bullet$, which means *RSM* contains siphons and traps, call them Σ . If for every resource place of Σ , there exists at least one token, that is $\forall p \in \Sigma: M_0(p) > 0$, each siphon contains a marked trap (MST), so *TCRSM* is deadlock-free[4].

2.3 Shared Composition of Sub Modules

To characterize the resources contention among inhomogeneous components have different processing routines, shared composition of sub modules is introduced. Jiang Changjun discussed the state constancy and behavior constancy on shared composition Petri nets[5].

Definition 4 (Shared composition). For timed colored Petri nets $TCRSM_i = (P_{W_i} \cup P_{M_i}, T_i, C_i, I_i, O_i, M_i)$, where $P_{W1} \cap P_{W2} = \Phi$, $P_{M1} \cap P_{M2} \neq \Phi$, $i = 1, 2$. If $TCRSM = (P, T, C, I, O, M)$ satisfies that: (1) $P = P_1 \cup P_2$,

$P_1 \cap P_2 \neq \Phi$; (2) $T = T_1 \cup T_2$, $T_1 \cap T_2 = \Phi$; (3) $I = I_1 \cup I_2$, $O = O_1 \cap O_2$; (4) if $p \in P_{M_1} \cap P_{M_2}$, let $C(p) = C_1(p) \cup C_2(p)$, else if $p \in P_{W_1} \cup P_{W_2}$, let $C(p) = C_i(p)$, $i = 1, 2$; (5) if $p \in P_{M_1} \cap P_{M_2}$, let $M(p) = \sum_{i=1}^{u_i} n_i \cdot m_i$, where $n_i = \max\{M_1(p)(m_i), M_2(p)(m_i)\}$, else if $p \in P_{W_1} \cup P_{W_2}$, let $M(p) = M_i(p)$, $i = 1, 2$, $TCRSM$ is the shared composition Petri nets of $TCRSM_1$ and $TCRSM_2$, for short, $TCRSM = TCRSM_1 O_p TCRSM_2$.

Property 4 (State constancy). Suppose that $TCRSM_i = (P_{W_i} \cup P_{M_i}, T_i, C_i, I_i, O_i, M_i)$ is timed colored Petri nets, $i = 1, 2$, and $TCRSM = TCRSM_1 O_p TCRSM_2$. If $\forall M \in R(M_0)$, $\exists M_i \in R(M_{0i})$, such that $\Gamma_{P \rightarrow (P_i - (P_i \cap P_j))}(M) = \Gamma_{P \rightarrow (P_i - (P_i \cap P_j))}(M_i)$, then $TCRSM$ is state constant, where $P_i = P_{W_i} \cup P_{M_i}$, $i = 1, 2$.

Proof: Let $\overline{TCRSM}_i = (\overline{P}_i, \overline{T}_i, \overline{F}_i, \overline{M}_{0i})$, $i = 1, 2$ be sub nets of $TCRSM_i$ and satisfy the following conditions: (1) $\overline{P}_i = P_{W_i}$; (2) $\overline{T}_i = T_i$; (3) $\overline{F}_i = I_i \cap (P_{W_i} \times T_i) \cup O_i \cap (T_i \times P_{W_i})$; (4) if $p \in P_{W_i}$, then $\overline{M}_{0i}(p) = M_{0i}(p)$. Obviously, $\forall \overline{M}_i \in R(\overline{M}_{0i})$, such that $\Gamma_{P \rightarrow P_{W_i}}(M) = \Gamma_{P \rightarrow \overline{P}_i}(M) \in R(\overline{M}_{0i})$, then $\exists M_i \in R(M_{0i})$, $\Gamma_{P \rightarrow P_{W_i}}(M) = \Gamma_{P \rightarrow P_{W_i}}(M_i)$ is satisfied. Since $P_i - (P_i \cap P_2) = P_{W_i}$, according to definition, $TCRSM$ satisfies state constancy.

State constancy reveals that sub modules keep mark of all places except shared ones unaltered after merged, which means in the merged module, new arrival component does not change the state of processing components. This property provides theoretic support for dynamic scheduling driven by events.

3 GA Based Multiple Aero-engine Static Scheduling

Static scheduling can be described as follows: all components are ready for processing at the beginning and there are no new arrivals, after scheduling the processing orders of all components are assume to be unaltered and machines never break down.

3.1 Static Scheduling Makespan Calculating

There are three ways to dealing with scheduling problem in Petri nets. One is by using reachability graph to determine a firing sequence of transitions to get the optimal schedule. The second way is by heuristic search of reachability graph. The last is using decision rules to solve conflicts[6]. In this paper, genetic algorithm is adopted to determine the firing sequence of transitions Petri nets.

Suppose that the processing order is given, which means the firing sequence of transitions with binding

color instances is $\sigma = \{t_i(a_{i,u_i}), t_j(a_{j,u_j}), \dots, t_k(b_{k,u_k})\}$, then the deterministic state transmission equation can be describe as: $M(n+1) = M(n) + \overline{W} \cdot S(n)$, where \overline{W} is weight function defined from colored arcs, $S(n)$ is the firing vector from n^{th} to $(n+1)^{th}$ step. According to the firing rules of timed Petri nets, if transition t_i with a binding color $a_{i,h}$ is fire enable, the firing procedure is summarized as follows:

1) Before $(n+1)^{th}$ step, suppose that arrival timestamp of the token with color $a_{i,h}$ in input operation place of transition t_i is $f_{t_i}(a_{i,h}, n)$, arrival timestamp of the token with color m_i in input resource place of t_i is $f_{t_i}(m_i, n)$, then the firing timestamp $e_{t_i}(a_{i,h}, n+1)$ of transitions t_i with a binding color $a_{i,h}$ is calculated from:

$$e_{t_i}(a_{i,h}, n+1) = f_{t_i}(a_{i,h}, n) \oplus f_{t_i}(m_i, n) \quad (3)$$

2) After $(n+1)^{th}$ step, transition t_i accomplishes firing after a duration d_i , the timestamp is $f_{t_i}(a_{i,h}, n+1)$, which is calculated from:

$$\begin{cases} f_{t_i}(a_{i,h}, n+1) = e_{t_i}(a_{i,h}, n+1) \otimes d_i \\ f_{t_i}(m_i, n+1) = f_{t_i}(a_{i,h}, n+1) \end{cases} \quad (4)$$

In formulas (4) above, max-plus algebra symbols “ \oplus ” and “ \otimes ” are introduced. The two symbols are defined respectively as follows: $a \oplus b = \max\{a, b\}$ and $a \otimes b = a + b$. Suppose that initial timestamp is $f_{t_i}(a_{i,h}, 0) = f_{t_i}(m_i, 0) = 0$ and the iterations ends after N steps when there are no enable transitions, then the makespan is calculated from $T = f_{t_1}(c, N) \otimes f_{t_2}(c, N) \dots \otimes f_{t_u}(c, N)$, where $u = |T|$.

Obviously, given the firing sequence of transitions, makespan can be calculated within linear time complexity. In the next section, genetic algorithm is adopted to determine the firing sequence of transitions Petri nets.

3.2 Genetic Algorithm Based Static Scheduling

Genetic algorithm behaves excellently when dealing with configuration optimization problems. In this paper, Genetic operator encodes the transition firing sequence of Petri nets into chromosome and the scheduling algorithm decodes the chromosome into schedule. In the later genetic algorithm search procedure, population evolves generation by generation to converge to an optimal or near optimal solution.

1) *Encoding* Cheng analyzed the advantages and disadvantages of nine encoding schemas for classical job shop scheduling[7]. In this paper, each gene represents a transition and chromosome represents the transitions firing sequence. Encoding of transitions firing sequence can be carried out by using natural numbers. To be specific, all transitions in the sub module are encoded by the same number which is different from other sub modules, and every transition can be distinguished from each other by order of number in chromosome.

Table 1. Encoding Schema of Chromosome

Process	1-1	2-1	1-2	2-2	2-3	...
Transition	$t_1(h_1)$	$t_1(h_2)$	$t_2(h_1)$	$t_2(h_2)$	$t_3(h_2)$...
Chromosome	1	2	1	2	2	...

Suppose that two instances of aero-engine module h_1 and h_2 are operated in work shop concurrently, then genes must be either "1" or "2". For example, as shown in table 1. if transitions in sub module of h_2 are described as $t_1(h_2)$, $t_2(h_2)$, ..., then the first "2" must represents $t_1(h_2)$, and the later must represents $t_2(h_2)$, the rest may be deduced by analogy.

2) *Selection* Single aero-engine maintenance scheduling aims for minimal makespan, therefore those chromosomes with minor scheduling makespan owned more fitness. Suppose that there are N individuals in the generation G , for each chromosome $L \in G$, its fitness is calculated from:

$$F(L) = (T_{max} - T(L)) / (T_{max} - T_{min}) + \varepsilon \quad (5)$$

where ε is a compensate value to prevent the fitness from being zero, T_{max} and T_{min} are the maximal and minimal makespan values of individuals from G respectively. If the individuals of next generation are chosen by roulette, then those fitter ones will survive at higher possibility.

If multiple aero-engines are operated in work shop concurrently, the fitness is multi-objective function. According to weighted sum approach proposed by Tasahiko, the weighted fitness function $F_{\Sigma}(L)$ is defined as follows:

$$F_{\Sigma}(L) = \sum_{i=1}^n w_i \cdot F_i(L) \quad (6)$$

where n is the number of aero-engines, $F_i(L)$ is the fitness function of i^{th} chromosome, w_i is the weighted factor of i^{th} chromosome.

3) *Crossover* Illegal chromosomes maybe results from ordinary crossover operation, to avoid which a new crossover operation strategy is proposed. To be specific, first dividing the components' numbers into two subsets named *set1* and *set2*, and making sure that the intersection of the two subsets is empty, then scan the two father chromosomes and let son chromosome be:

$$son1 = \Gamma_{parent1 \rightarrow set1}(parent1) \cup \Gamma_{parent2 \rightarrow set2}(parent2) \quad (7)$$

where $\Gamma_{parent1 \rightarrow set1}(parent1)$ represents the projection of *parent1* from *parent1* to subset *set1*, finally exchanging *parent2* with *parent1*, a new son chromosome is produced after repeating the operation above.

4) *Mutation* Mutation is fairly straightforward. The procedure is to exchange two genes in chosen chromosome randomly.

4 Rolling Horizon Based Dynamic Scheduling

Aero-engine maintenance is a dynamic procedure and may be interrupted by stochastic events unexpected, therefore seeking for dynamic scheduling strategies adaptive to the alteration seems to be necessary considerably. Obviously, it is robust and sensitive to unexpected events, which differs from static scheduling.

4.1 Rolling Horizon and Scheduling Sub Module

Inspired by the rolling horizon optimization for the predictive control technology, Fang Jian proposed a period and event-driven rolling horizon scheduling strategy, which means scheduling objects are those components included in rolling horizon[8]. In this paper, corresponding definitions about rolling horizon in timed colored Petri nets are defined as follows:

Definition 5 (*Rolling horizon*). Rolling horizon C_H is defined as the subset of colors of the merged timed colored resource sharing module $TCRSM$, that is $C_H \subseteq C$. The color set number of rolling horizon $|C_H|$ is called capacity.

Definition 6 (*Dynamic scheduling sub module*). For sub nets $CPN_H = (P_H, T_H, C_H, I_H, O_H, M_{H0})$ of $TCRSM$, which satisfies: (1) $P_H = \{p \in P \mid C_H(p) \neq \Phi\} \cup P_M$; (2) $T_H = \{t \in T \mid C_H(t) \neq \Phi\}$; (3) if $p \in P_H$, and $t \in T_H$, let $I_H(p, t) = I(p, t)$; (4) if $p \in P_H$, and $t \in T_H$, let $O_H(p, t) = O(p, t)$, CPN_H is defined as the dynamic scheduling sub module of $TCRSM$ corresponding to Rolling horizon C_H .

There are two ways to construct scheduling sub module: one is to reconstruct the module by "bottom-up modelling" and keep the marking of operation places and resource places unaltered in $TCRSM$, the other is to decomposed the merged $TCRSM$ into two sub ones and one of whose color set is rolling horizon. The scheduling sub module is the reduction of merged system and used to dynamic scheduling.

4.2 Rescheduling Driven by Events and Period

There are two strategies for rescheduling: continuous scheduling and periodical scheduling. The former executes rescheduling once events emerges, which can cope with unexpected events, while the latter executes rescheduling periodically. In this paper, a hybrid strategy is adopted. Some key events including new project arriving, due date changing and machine breaking down are defined as following. If any key event takes place, then executes rescheduling, else executes rescheduling periodically.

1) *New components* C_N Arriving New instances should be added to module, which means new colors should be added to color set of merged $TCRSM$, that is $C'_W(P_W) = C_W(P_W) \cup C_N$, $C'_W(T_W) = C_W(T_W) \cup C_N$, and

keep the state of processed and processing components unchanged, that is $\forall p \in P_W, \forall c \in C_W : M'(p)(c) = M(p)(c)$.

2) *Changing of due date T_{ci}* Suppose that $F_i(L)$ is the makespan of i^{th} chromosome, w_i is the weighted factor of i^{th} chromosome, if the variation value of T_{ci} is ΔT_{ci} , then w_i should be adjusted, let $w'_i = w_i \cdot (1 + \Delta T_{ci} / F_i(L))$ and the weighted fitness function $F_S(L)$ should be adjusted accordingly.

3) *Machine $m \in M$ breaking down* If a machine breaks down while machining, then remove the corresponding colored token kept by transition and keep the colored tokens' number $M(p)$ in resource places unchanged, else if the machine is idle and becomes unusable, then let $M'(p) = M(p) - 1$. If the

broken down machine is recovered and becomes usable, the let $M'(p) = M(p) + 1$, where $p = h(m)$, h is the mapping function from machines to resource places.

5 Case Studying

Assembly workflow of aero-engine is shown in Figure 1, eight modules of aero-engine at the most left denote branches in the assembly procedure where each branch means one part of engine. Each part of an aero-engine is machined, balanced and assembled. In addition, blocks with the same name denote the same type of machine. The number above a block means the operation time of the operation on this machine. Arrows means sequence of operations.

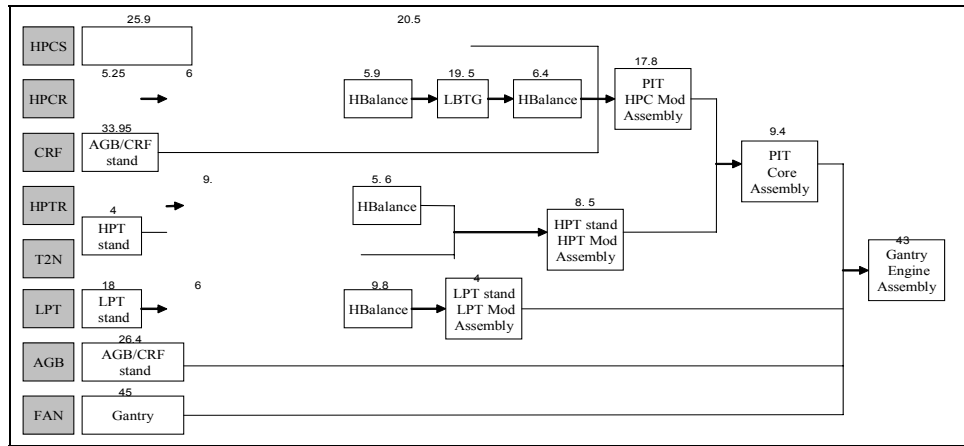

Figure 1. Aero-engine assembly workflow

Aero-engine assembly module represents by Petri nets is shown Figure 2. The mapping procedures from workflow can be described as follows: firstly the Resource Shared Modules of HPC, T2N, HPTR, HPCR,

LPT, CRF, AGB, FAN are constructed respectively according to the workflow of each module, then merge all eight Resource Shared Modules by shared composition.

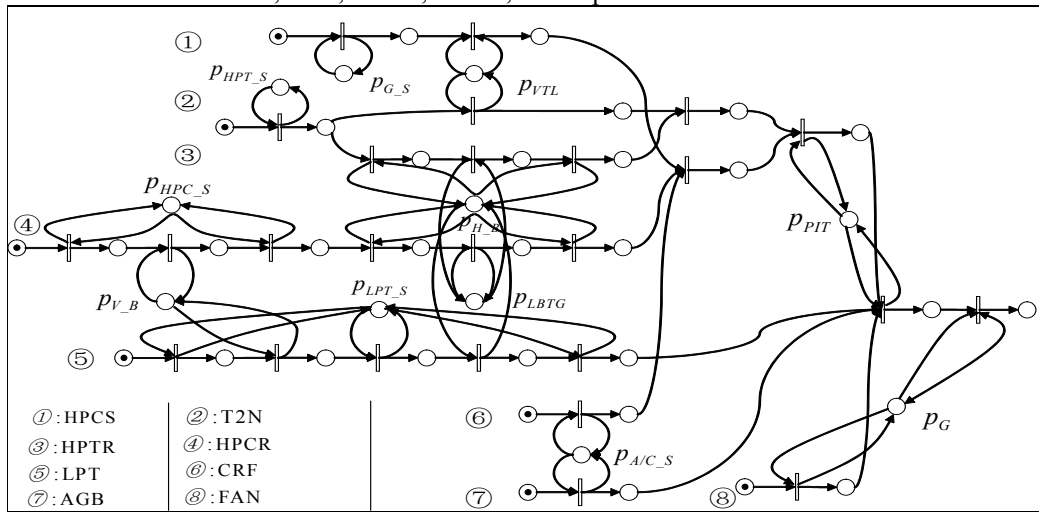

Figure 2. Petri nets module of aero-engine assembly

As shown in Figure 3, we choose 3 aero-engines situation with starting simultaneously. The rationality of Petri nets is verified by three aspects: (1) All processes follow the sequence of workflow strictly. (2) All processes are executed one by one without overlapping. (3) All processes are executed as closely

as possible, which reduce the running time and increase the efficiency of utilization of machines.

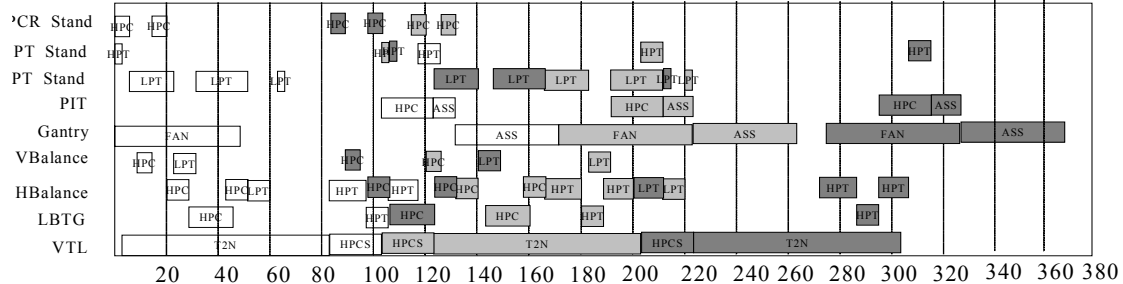

Figure 3. Static scheduling result for 3 aero-engines

From static scheduling result, for 1st aero-engine it takes 174.7 hours to accomplish the assembly procedure, while it takes only 366.4 hours for the 3 aero-engines. This is because the total time duration of aero-engines is only regarding the path which require the longest operation time. We maximize the utility of critical machines to minimize the time duration of processes operated on them. Thus, the makespan is not proportional to the number of aero-engines.

6 Conclusion

To cope with the problem of concurrency and asynchrony of multiple aero-engines maintenance, shared composition method of Petri net is adopted to realize bottom-up modelling. The constructed model characterizes interactions between components with different processing routines and machine resources. Genetic algorithm is adopted to arrange firing sequence of transitions for static scheduling. To deal with discrete events emerge in workshop, a dynamic scheduling strategy uses rolling horizon composed by colors is presented, which made the model more adaptive and robust.

Acknowledgments

The authors also wish to acknowledge the financial support of the National Natural Science Foundation of China (60373102, 60572174).

Correspondence to:

Xinmin Tang
 School of Mechatronics Engineering
 Harbin Institute of Technology
 Harbin, Heilongjiang 150001, China
 Telephone: 01186-451-8641-3847
 E-mail: txmofhit@hit.edu.cn

References

- [1] P. Samaranyake, Development of engineering structures for scheduling and control of aircraft maintenance, *International Journal of Operations & Production Management* 2002;22(8): 843-867.
- [2] Junyu Chen, The Study of Maintenance Scheduling in Aviation Engines, National Chiao Tung University, Taiwan, 2003: 9-12.
- [3] Mu Der Jeng, Frank DiCesare, Synthesis Using Resource Control Nets for Modelling Shared-Resource Systems, *IEEE Transactions on Robotics and Automation* 1995; 11(3):317-327.
- [4] Claude Girault, Rüdiger Valk, *Petri Nets for Systems Engineering A Guide to Modelling , Verification, and Application*, Springer-Verlag Berlin Heidelberg, 2003:214-215.
- [5] Jiang Changjun, Dynamic constancy of Petri nets, *Science in China (Series E)* 1997; 27(6):567-573.
- [6] Zhonghua Huang, Zhiming Wu, Deadlock-Free Scheduling Method for Automated Manufacturing Systems Using Genetic Algorithm and Petri Nets, *Proceedings of the 2004 IEEE International Conference on Robotics & Automation* 2004;566-571.
- [7] Pan Quanke, Multi-Objective Scheduling Optimization of Job-shop in Intelligent Manufacturing System, Nanjing University of Aeronautics and Astronautics, Nanjing, 2003:20-25.
- [8] Fang Jian, Xi Yugeng, "The Genetic Algorithms-Based Rolling Horizon Scheduling Strategy," *Control Theory and Applications* 1997;14(4):589-594.

Properties of Recombinant *Sulfolobus shibatae* Maltooligosyltrehalose Synthase Expressed in HMS174

Wen Shen¹, Jin Wu², Jinfu Wang¹, Yanhe Ma², Ziyuan Duan², Yifeng Gong^{1*}

¹ Ministry of Education Key Laboratory of Xinjiang Endemic and Ethnic Disease, Shihezi University, Shihezi, Xinjiang 832003, China, altai_2003@163.com

² Institute of Microbiology, Chinese Academy Sciences, Beijing 100101, China

Abstract: A 2,187 bp DNA fragment encoding maltooligosyltrehalose synthase (MTS) was cloned from *Sulfolobus shibatae*, and expressed in HMS174. The recombinant enzyme had a molecular weight of about 74 kDa. The purified protein showed an almost absolute requirement for Mg²⁺, Mn²⁺, Co²⁺, and Ca²⁺, and was not very active with Cu²⁺ and Zn²⁺. At the other hand, the enzyme was stable to heating at 80°C for up to 3 h and only caused a 20% loss of activity. Similarly, the enzyme was also stable from pH 4 to 7 when it was placed in a series of pH buffers. The final results also indicated that the protein encoded by MTS showed a maximum activity at 60°C or pH 5.5 when it was incubated with maltopentaose. [Nature and Science. 2006;4(2):52-57].

Key Words: Maltooligosyltrehalose synthase; trehalose; *Sulfolobus shibatae*

Introduction

Trehalose is a nonreducing disaccharide, and its two glucose molecules are linked together in an α , α -1, 1-glycosidic linkage, which has been found in various organisms, including bacteria, algae, fungi, yeasts, insects, nematodes, shrimps, and some plants (Alan, 2003). There are three possible anomers of trehalose, that is, α , β -1,1-, β , β -1,1-, and α , α -1,1-, only the α , α -trehalose has been isolated from and biosynthesized in living organisms. Many of these organisms produce and store trehalose, sometimes in amounts as high as 10% to 20% of their dry weight. In nature, trehalose serves not only as a carbohydrate reserve for energy and/or for the synthesis and preservation of cell membranes but also as an agent that protects against a variety of physical and chemical stresses, such as heat, cold, desiccation, and anoxia (Marielle, 2005). In addition, this sugar allows desert plants to tolerate naturally occurring stresses during cycles of dehydration and rehydration. So, trehalose has been used extensively as additives,

stabilizers, and sweeteners that are quite useful in the food, cosmetic, and pharmaceutical industries.

One trehalose-producing pathway is mediated by maltooligosyltrehalose synthase (MTS) and maltooligosyltrehalose trehalohydrolase (MTH). MTS converts α -1,4-glycosidic linkage into α -1, 1 linkage to produce the intermediate of maltooligosyltrehalose. Then, MTH hydrolyzes the second α -1,4-glycosidic linkage of the intermediate to release free trehalose (Maruta, 1995).

S. shibatae, a thermoacidophilic crenarchaeon growing optimally at pH 2 and 80°C, was known to contain the enzymes of MTS and MTH that can synthesize trehalose from maltooligosaccharides or soluble starch (Di Lernia, 1998). In the present study, we cloned a DNA fragment encoding MTS from *S. shibatae*. The gene was expressed in HMS174 and its recombinant products were characterized to determine their *in vitro* activities.

1. Materials and Methods

1.1 Bacterial strains and culture conditions

The *E. Coli* expression strain HMS174 was used for cloning and expression studies, which contains a chromosomal IPTG-inducible T7-RNA *pol* gene. Strain was cultured in L broth and on L agar supplemented with 100 μ g/ml ampicillin at 37°C. *S. shibatae* was grown aerobically under continuous shaking in a medium at 78°C. Cells were grown to an OD₆₀₀ of 1.0 prior to harvesting and their extracts were prepared according to Hudepohl et al.

1.2 Reagents and materials

All DNA manipulation enzymes, including restriction endonucleases, polymerases, RNase, DNA ladders, protein markers, ligase, PCR reagents, and Wizard® SV Gel and PCR Clean-Up system were supplied by Promega. All other reagents were from reliable chemical companies, and were of the best grade available.

1.3 Preparation of *S. shibatae* genomic DNA

To prepare DNA, *S. shibatae* was cultured and harvested. Cells were resuspended in TE (10 mM Tris, pH8.0/ 1 mM EDTA) containing 0.5% SDS, and proteinase K was added to 1mg/ml. After incubation for 2-4 h at 37°C and extraction with phenol, DNA was precipitated with ethanol (Asthana, R.K. 2005).

1.4 Polymerase chain reaction

A 50 μ l PCR mixture was carried out containing 5 μ l of 10 × PCR buffer, 1 μ l of deoxynucleoside triphosphates, 10 μ l of each primer, 1 μ l of template DNA, and 1 μ l of *Taq* DNA polymerase. DNA was amplified under the following conditions: 5 min at 94°C, followed by 30 cycles of 1 min at 94°C, 1 min at 54°C, and 2 min at 72°C and a final extension at 72°C for 10 min. The MTS-specific primers used in this study were designed using DNAMAN according to the sequence *S. shibatae* unloaded from GenBank. The upstream and downstream primers, 5' -TCACATATGATAATAGGC

ACATATAGGCT-3' and 5' -CAAGGATCCACTCCC TTTTTTCAGT-3' , were designed to contain the restriction sites of *Nde* I and *Bam* HI in the 5' (dash) ends, respectively.

1.5 Construction of expression plasmids

The 2,187 bp PCR product was digested with *Nde* I and *Bam* HI, and ligated with the *Nde* I- and *Bam* HI-digested expression plasmid pET21a to generate the plasmid p269A317. The identification and fidelity of the amplification were conformed by DNA sequencing. The p269A317 was transformed into the expression strain HMS174. The positive clones were screened by Blue/White color screening on Luria-Bertani plates containing the appropriate antibiotic, 0.1 mM IPTG and 40 μ g/ml X-Gal incubating overnight at 37°C.

1.6 Purification of express product

The HMS174 transformed with p269A317 was grown in 2 liter Luria-Bertani medium containing ampicillin and induced by IPTG for 4 h at 37°C with shaking. Cells were harvested by centrifugation, washed with phosphate-buffered saline. The cells were broken by subjecting the cell suspension to two 3-min pulses of sonication with a Braun probe sonicator at 80% of maximum setting. The broken cell suspension was then centrifuged at 40,000 × g for 15 min to remove unbroken cells and cellular debris, and the resulting supernatant liquid was applied to a nickel ion column eluting with imidazole for the following experiments.

2 Results

2.1 Trehalose from maltooligosaccharides

Enzymatic activities of the purified recombinant MTS proteins were analyzed by HPLC by using maltooligosaccharides as substrates. In the reaction with MTS, most of maltopentaose was converted to an intermediate. This intermediate has been identified as maltotriosyltrehalose (Figure 1).

2.2 Properties of the MTS

2.2.1 Optimum conditions of the MTS activity

Incubations were prepared at various pH values as shown in the figure. The pH optimum of this activity was 5.5 and had almost no activity at either pH 4 or 7 in contrast to many nonspecific acid or alkaline phosphatases that usually have the maximum activity at

around pH 5.0 or 9.0 as shown in *Figure 2*,

The enzyme exhibited a maximum activity from 60 to 65°C and had a higher activity from 50 to 80°C than those at other temperatures when it was incubated with different temperatures from 35 to 90°C as shown in *Figure 3*.

Figure 1. **Production of trehalose from maltooligosaccharides.** HPLC analyses of reaction products obtained from maltooligosaccharides by enzymatic activity of recombinant MTS proteins. A 0.1- μ mol portion of maltopentaose was reacted with 5 μ mol of purified recombinant enzyme MTS. Reaction was terminated after 3 h. M₅, maltopentaose; M₃-T, maltotriosyltrehalose.

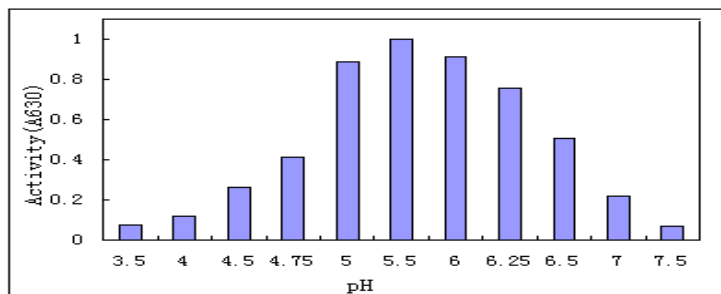

Figure 2. **Effect of pH of incubation mixture on activity of recombinant MTS.** Incubations were prepared as described in the text but contained buffers at various pH values as shown in the figure.

Figure 3. **Optimum temperature of MTS activity.** MTS proteins were incubated at various temperatures ranging from 35 to 90 °C. Each sample was then tested for its activity to indicate the optimum temperature for the activity.

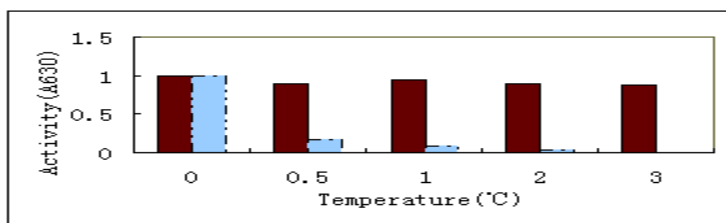
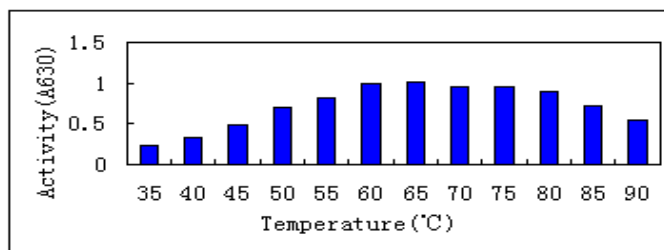

Figure 4. **Heat stability of the recombinant MTS.** MTS proteins were incubated at 80 and 90°C. *Black* was experiment at 80°C, *azure* was experiment at 90°C.

Figure 5. **pH stability of recombinant MTS.** MTS was incubated under various pH values at room temperature for 1 h.

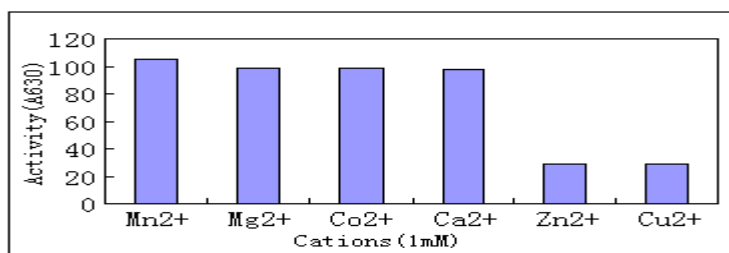
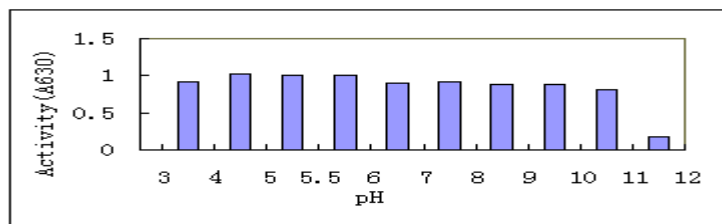

Figure 6. **Effects of cation on MTS activity.** Incubations were as described in the text but contained various cations at the concentration of 1 mM as indicated in the figure.

2.2.2 Stability of the MTS activity

MTS was incubated with a series of pH buffers for 1 h at room temperature to determine the stability of MTS. The result suggested that the enzyme was quite stable from pH 4 to 7 as shown in Figure 5.

When the enzyme was placed in a hot water bath at 80°C and 90°C, the results indicated that the enzyme was quite stable to heating at 80°C for 3 h, which only caused a 20% loss of activity. In fact, even at 90°C, the enzyme retained significant activity for several minutes and then lost activity as shown in Figure 4.

2.2.3 Effect of cations on the activity of MTS

MTS showed an almost absolute requirement for the cation of Mn²⁺, as shown in Figure 6. The data in this figure also showed that Ca²⁺, Mg²⁺, or Co²⁺ worked to some extent, but was much less effectively than Mn²⁺ at the concentration of cation of 1 mM. On the other hand, there was a great loss of activity caused by Cu²⁺, or Zn²⁺ when it was added to the system individually with the concentration of 1 mM.

3 Discussion

Many studies indicated that trehalose has the extensive biological functions, and scientists have found at least three trehalose-producing pathways in

the biological world. And, one of them is MTS and MTH-based pathway that can utilize many substrates, such as the maltooligosaccharides and soluble starch, the most abundant maltodextrin in nature. However, another main pathways for the synthesis of trehalose is the transfer of glucose from UDP/GDP-glucose to glucose-6-P to produce trehalose 6-phosphate where organisms must utilize GDP/UDP-glucose or other glucose nucleotides as glucosyl donors for trehalose synthesis (Maruta, 1995). The trehalose-producing genes of MTS had been found in many organisms, including *S. solfataricus* KM1, *Arthrobacter sp.* Strain Q36, *Rhizobium sp.* Strain M-11, *M. tuberculosis*, and *B. helvolum* (Yong, 2000), etc. In this study, we cloned and expressed *S.shibatae* MTS gene, a 2,187 bp fragment encoding 728 amino acids, in HMS174, and researched the properties of this recombinant protein the first time.

We tested the possibility of using longer maltooligosaccharides as substrates in the enzyme reaction for trehalose production and most of them were converted to an intermediate. This intermediate has been identified as maltotriosyltrehalose.

The purified recombinant protein was incubated with various pH values and temperatures, respectively. The final results indicated that the optimum pH value

and temperature were 5.5 and 60°C where the enzyme could exhibit the biggest activity, respectively. And what is more, the recombinant enzyme was quite stable when the enzyme was incubated with different pH values from 4 to 7 for 1 h, and had a 20% loss of activity for at least 3 h of heating at 80°C. However, the optimum pH value and temperature of the trehalose-producing enzyme from *Pimelobacter sp.* R48 was 7.5 and 20°C, respectively (Keiji, 1996). The identical enzyme from *Arthrobacter sp.* Q36 also had the optimum temperature of 35°C (Nakada, 1995). The reason why they had the different temperatures for maximum enzymatic activity might be that *S.shibatae* is a thermoacidophilic crenarchaeon, which formed a specific enzymatic system under such a condition in the long evolutionary process. And other properties of MTS isolated from *S.solfataricus* KM1 were the stability in a series of pH values from 5.0 to 6.0 and a series of temperatures from 70 to 80°C when it served as a catalyzer (Kobayashi, 1990). Based on BLAST analysis (<http://www.ncbi.nlm.nih.gov/BLAST>) of the predicted *S. shibatae* MTS nucleic acid and amino acid sequences, which share homology with those of *S.solfataricus* KM1 at 96% and 98% identity, respectively. At the other hand, the cations of Mn^{2+} , Ca^{2+} , Mg^{2+} , or Co^{2+} had a great impact on enzymatic activity. But, the cations of Cu^{2+} , or Zn^{2+} had a weaker impact than those the above cations had. These results caused by cations were identical with those produced by the trehalose-producing enzymes coming from *Pimelobacter sp.*R48 and *M.smegmatis* (Keiji, 1996).

Now, Despite the properties of the recombinant protein cloned from *S.shibatae*, very little is known about the mechanism of the protein that was quite stable when it was incubated with a more lower pH buffers and higher temperatures. We are currently designing experiments to explore these mechanisms that make the enzyme kept their activity under a specific condition.

Acknowledgment

This work was supported by a grant from the Institute of Microbiology of the Chinese Academy Sciences.

Correspondence to:

Yifeng Gong
Ministry of Education Key Laboratory of Xinjiang Endemic and Ethnic Disease
Shihezi University
Shihezi, Xinjiang 832003, China
Email: altai_2003@163.com

References

1. Alan D, Elbein YT, Pan IP, David C. New insights on trehalose: a multifunctional molecule. *Glycobiology* 2003;13:17-7.
2. Asthana RK, Srivastava S, Singh AP, Kayastha AM, Singh SP. Identification of maltooligosyltrehalose synthase and maltooligosyltrehalose trehalohydrolase enzymes catalysing trehalose biosynthesis in *Anabaena* 7120 exposed to NaCl stress. *J Plant Physiol* 2005;162(9):1030-7
3. Chen W, Liu L, Sun P, Jin C. Cloning and expression of the gene encoding maltooligosyl trehalose synthase from *Sulfolobus shibatae* in *E.coli*. *Wei Sheng Wu Xue Bao* 2000; 40(1):57-61.
4. Di Lernia I, Morana A, Ottobrino A, Fusco S, Rossi M, De RM. Enzymes from *Sulfolobus shibatae* for the production of trehalose and glucose from starch. *Extremophiles*. 1998;2(4):409-16.
5. Keiji T, Tomoyuki N. Cloning sequencing of trehalose synthase gene from *Pimelobacter sp.* R48. *Biochimica et Biophysica Acta* 1996;1290:1-3.
6. Kobayashi K, Kato M, Miura Y, Kettoku M, Komeda T, Iwamatsu A. Gene cloning and expression of new trehalose-producing enzyme from the hyperthermophilic archaeum *Sulfolobus solfataricus* KM1. *Biosci. Biotechnol Biochem* 1990;60:1882-5.
7. Marielle T, Xavier M, Andreas W, Henrike G, Sergey S, Mohamed C, Dietmar S, Reinhard K, Susanne M, Mamadou D. The Crucial Role of Trehalose and Structurally Related Oligosaccharides in the Biosynthesis and Transfer of Mycolic

- Acids in Corynebacterineae. J Biol Chem 2005;280:26573-5.
8. Maruta K, Hattori K, Nakada T, Kubota M, Sugimoto T, Kurimoto M. Cloning and sequencing of trehalose biosynthesis genes from *Rhizobium* sp. M-11. Biosci Biotechnol. Biochem 1996;60:717-20.
 9. Maruta K, Hattori K, Nakada T, Kubota M, Sugimoto T, Kurimoto M. Cloning and sequencing of trehalose biosynthesis genes from *Arthrobacter* sp. Q36. Biochim Biophys Acta 1996;1289:10-3.
 10. Maruta K, Nakada T, Kubota M, Chaen H, Sugimoto T, Kurimoto M. Formation of trehalose from maltooligosaccharides by a novel enzymatic system. Biosci Biotechnol Biochem 1995;59:1829-34.
 11. Naka T, Maruta K. Purification and properties of a novel enzyme, Maltooligosyltrehalose synthase, from *Arthrobacter* sp. Q36. Biosci Biotech Biochem 1995;59(12);2215-8.
 12. Yong HK, Tae KK, Sungsoon P, Hak SS, Jongjoo C, Chung HK, Jukon K, Jong SL, Yang DC. Trehalose Synthesis by Sequential Reactions of Recombinant Maltooligosyltrehalose Synthase and Maltooligosyltrehalose Trehalohydrolase from *Brevibacterium helvolum* Applied and environmental microbiology 2000;4620-4.

Ten-minute DNA Release Kits

- A novel approach to obtain DNA easily in modern biological science

Huajie Zhu **, Yucui Zhu **, Hongbao Ma ***, Jiasheng Lu *

* Jacksun Easy Biotech Inc., New York, NY, USA, hjz689@yahoo.com; www.jacksunbio.com

** Columbia University, New York, NY, USA, hjz42@columbia.edu

*** Michigan State University, East Lansing, MI, USA, hongbao@msn.edu

Abstract: Genomic DNA study has been used widely in biology, genetics, reproduction, clinical medicine and clinical medicolegal. This article describes characterization and protocol of the new product 10-minute DNA Release Kit that provides a reliable, simple, and quick approach, by taking 10 minutes at 86°C for DNA release and desired DNA extract obtaining. The product will save scientists' time and give better result on the DNA extract. [Nature and Science. 2006;4(2):58-70].

Keywords: DNA; extract; knowledge; PCR

1. Introduction

Genomic DNA study has been used widely in biology, genetics, reproduction, clinical medicine and clinical medicolegal. It is very important for the genomics study to obtain the desired DNA extract easily and quickly. The 10-minute DNA Release Kit provides a reliable, simple, and quick approach, by taking 10 minutes at 86°C for DNA release and desired DNA extract obtaining.

The 10-minute DNA Release Kit not only offers a wide range on the desired DNA extract (Figure 1), but also gives a good expression of multi-primers in polymerase chain reaction (PCR) (Figure 2). And, it is not only used for on genome expression by the analysis of PCR, but also used on mitochondrial DNA mutation for the diagnosis and treatment observation of mitochondrial disease, which can be done by the analysis of PCR/RFLP (Restriction Fragment Length Polymorphism) and point mutation (Figure 3).

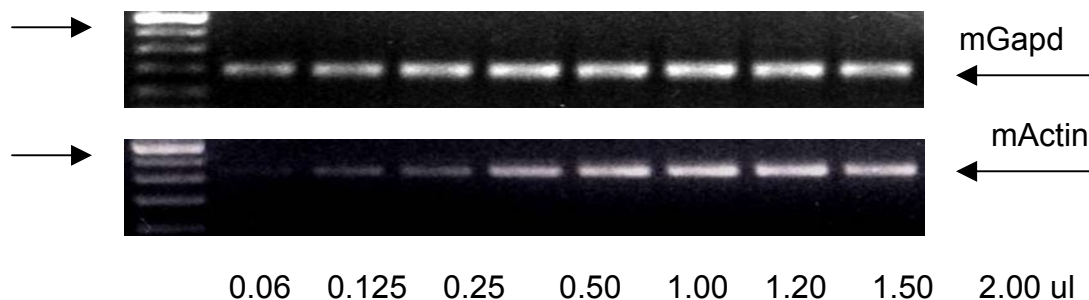
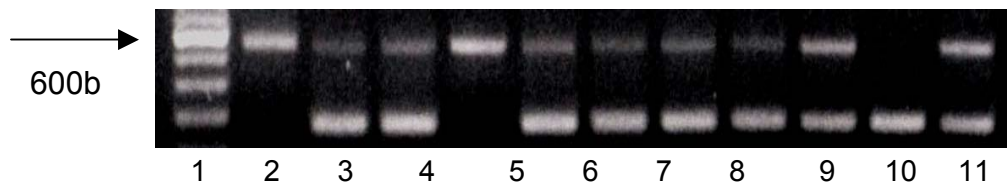

Figure 1. mGapdh and mActin expression on the DNA volume-dependent effective with the DNA Extract from mice tail



The expression of P53 +/+ at No. 1, 4;
P53 +/- at No. 2, 3, 5, 6, 7, 8, 9, 11;
P53 -/- at No. 10

Figure 2. Genotyping the P53 transgenic mouse with 10 Minute DNA Kit

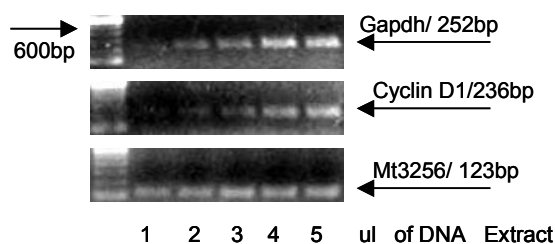

Figure 3A. Primer expression on DNA volume-dependent effective with the DNA extract from human blood

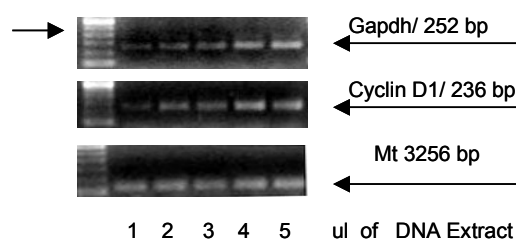

Figure 3B. Primer expression on DNA volume-dependent effective with the DNA extract from human urine

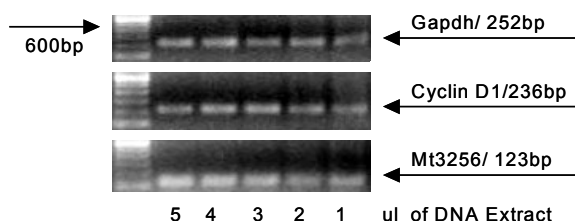

Figure 3C. Primer expression on DNA volume-dependent effective with the DNA extract from human Saliva

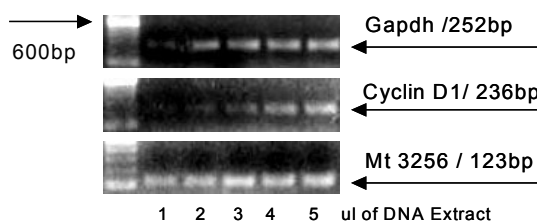

Figure 3D. Primer expression on DNA volume-dependent effective with the DNA extract from human Hair Follicle

Figure 3. Primer expression on DNA volume-dependent effective with the DNA extract

(1) Primer, Gapdh and Cyclin D1 are designed from human Genomic DNA Sequence.

Gapdh	Start	Sequence	Size
Left prime	108	GAA GGT GAA GGT CCG AGT CA	252bp
Right primer	359	TTG ATT TTG GAG GGA TCT CG	
Cyclin D1			
Left primer	2096	CCA TTC CAT TTC CAA GCA CT	236bp
Right primer	2331	TCA TCCTGG CAA TGT GAG AA	

(2) Primer mt3256 is designed from human mitochondrial DNA sequence.

This is to analyze myDNA mt3256 (C->T) mutation. Normally, mt3256 point is the C-Cytosine. The C is replaced with T-thymine when the 3256 point mutation occurred. The mt3256 mutation is associated with MELAS (Mitochondrial Encephalomyopathy, lactic Acidosis, and Strokelike Episodes).

Mt3256	Start	Sequence	Size
Left primer	3230	GTT AAG ATG GCA GCG CCC GGT AAG CG	123bp
Right primer	3353	GCG ATT AGA ATG GGT ACA ATG	

PCR program: 33 cycles; 50 seconds at 95°C; 50 seconds at 56°C; 60 second at 72°C.

2. The Kits 1-7 function description and protocols

2.1 Ten-minute DNA Release Kit-1, for mouse tail, ear-DNA-PCR. Cat# JZ-001.

From the mouse tail, ear and any organs tissue to obtain the desired DNA to run PCR for the transgenic

mouse genotyping, PCR/RFLP-point mutation and any gene expression.

2.2 Ten-minute DNA Release Kit-2, for mouse tail and tissue-purified DNA-PCR and Southern etc. The catalogue number is Cat#JZ-002.

From the mouse tail or any tissue to obtain the purified DNA within 20 minutes after the DNA release. The ratio of DNA OD260/280 nm is higher than 1.70. With the purified DNA to run PCR and Southern for the transgenic mouse genotyping, PCR/RFLP-point mutation and any other gene expression.

2.3 Ten-minute DNA Release Kit-3, for blood-DNA-PCR. Cat# JZ-003.

2.4 Ten-minute DNA Release Kit-4, for urine-DNA-PCR. Cat# JZ-004.

2.5 Ten-minute DNA Release Kit-5, for saliva-DNA-PCR. Cat# JZ-005.

2.6 Ten-minute DNA Release Kit-6, for hair follicle-DNA-PCR. Cat# JZ-006.

From the blood, urine, saliva and hair follicle to obtain the desired DNA to run PCR for PCR/RFLP-point mutation and any other gene expression. The desired DNA extract shows the volume dependent effective on the different genomic DNA expression (Figure 3A,B,C,D).

2.7 Ten-minute DNA Release Kit-7, for culture cells-DNA-PCR-Southern etc. Cat# JZ-007.

From the cultured cells to obtain the purified DNA easily and quickly. The purified DNA could be used for any purpose on the genomic DNA expression.

3. Detail Descriptions of Ten-minute DNA Release Kits 1-7

3.1 Ten-minute DNA Release Kit-1

Ten-minute DNA Release Kit-1 is for mouse tail or ear-DNA-PCR, and for the smallest tissue, body liquid pellet and the material stained by biologic trace also.

Catalogue number of Ten-minute DNA Release Kit-1 is JZ-001.

The preliminary protocol of Ten-minute DNA Release Kit-1 is as the following

3.1.1 Aim

3.1.1.1 It is easy and quick from mouse tail or ear to obtain the desired DNA to run PCR for transgenic mouse genotyping.

3.1.1.2 It is also easy and quick to obtain the desired DNA extract form any organ tissue and body liquid pellet.

3.1.1.3 It is special to obtain the desired DNA extract from material which was stained by blood on any biologic body liquid.

3.1.1.4 For the detail of items b and c to see the protocols 5 and 6 on the purpose of Kit-1 gene expression, please read the Kit-1 protocol 5 first.

3.1.2 Have been ready for the equipments?

3.1.2.1 It is fine for this kit to have any type of thermo machine or water bath which could set up the constant temperature between 86-90°C.

3.1.2.2 A room temperature eppendorf centrifuge machine with the speed 10,000-15,000 g should be available.

3.1.2.3 1.5 ml Eppendorf tubes, tips and micro-pipettor with the scalar 10-200 ul.

3.1.2.4 Vortex or mixture machine is available.

3.1.3 Contents Table (Table 1)

Table 1. Ten-minute DNA Release Kit-1 contents table

Catalogue Number	DNA Release Buffer		Work for Samples	Store and Use
	Name	Volume		
JZ-001-1	Kit1-B1	4 ml	100	1.It is qualified for 6 months at 5-29°C. 2.Warm to RT before using if it was kept at 4°C.
JZ-001-2	Kit1-B2	6 ml		

3.1.4 Work Table (Table 2)

Table 2. Ten-minute DNA Release Kit-1 work table

Steps	Action	Show
Step 1	Place a mouse tail 1.5-3 mm, or ear tissue 2x3 mm, (or any tissue and/or material stained the body liquid) to a eppendorf tube. Add 40 ul of Kit-1 B1 to the tube. See show.	
Step 2	Put the tube at 86°C in a Thermo-Mathine or Water Bath, not shaking, for 6-8 minutes (86-90°C is allowed).	
Step 3	Add 60 ul of Kit-1 B2 to the tube, flick it 3-5 times, then keep the tube at room temperature (RT) for 2-3 minutes.	
Step 4	Centrifuge the tube at 15,000 g X 3 minutes. in RT. (The 0-4°C is not allowed).	
Step 5	Pipette the clear aqueous phase 60 ul to a fresh tube, which is the desired DNA extract for PCR. Take 1-3 ul DNA as the templet to run PCR in 20-25 reaction volume.	
Note	If you use the kit first, it's better to do expression on your primer by taking the DNA extract 1-3 to run PCR separately to test the working range.	

3.1.5 Treating for Another Organs Tissue:

3.1.5.1 Cut organ tissue to 1-3 mm³ (1-12 mg).

3.1.5.2 If the organ tissue is with blood or another dirty trace, please:

3.1.5.2.1 Rinse 2-3 times with PBS without Ca⁺⁺ and Mg⁺⁺.

3.1.5.2.2 Touch dry the tissue on the paper towel, then follow the work table.

3.1.5.3 If the organ tissue is clean, like skin etc, go to follow the work table.

3.1.5.4 For the other small tissue:

3.1.5.4.1 The tissue is punching from human skin, animal ear or any other organs

3.1.5.4.2 The tissue is obtained by laser punching or scrape from human or animal.

3.1.5.4.3 If the tissue is embedded by paraffin, you can scrap a few pieces to an eppendorf tube.

3.1.5.5 For the material that is stained by biologic trace: Cut the material to the smallest pieces and place the smallest pieces to an eppendorf

tube, then follow the work table to process it like to do mouse tail.

Southern for the transgenic mice genotyping etc.

3.1.5.6 For any deposit pellet which is from any body liquid: Place the body liquid to an eppendorf, centrifuge at 5000 g X 3, get rid of the supernatant, keep the pellet in the tube, and go to follow the work table.

3.2.1.2 If you want to use the Kit to obtain purified DNA from any tissue for any purpose of gene expression, please read protocol Kit 2-6 first.

3.1.6 Buffer Volume for the Another Organs Tissue

The ratio of Kit-1 B1 and Kit-1 B2 is 1:1.5, which means according to the tissue or liquid pellet size, if you choose to use 1 ul of Kit1-B, you need to use 1.5 ul of Kit1-B2.

3.2.2 Have been ready for the equipments?

3.2.2.1 It is fine for this kit to have any type thermo-machine, or water bath if they can set up the constant temperature between 86-90°C.

3.2 Ten-minute DNA Release Kit-2

Ten-minute DNA Release Kit-2 is for mouse tail and tissue-purified DNA—PCR-Southern. It is for 100 samples. Its catalogue number is JZ-002.

3.2.2.2 A room temperature eppendorf centrifuge machine with the speed 10,000-15,000 g is needed for the running.

The preliminary protocol of Ten-minute DNA Release Kit-2 is as the following:

3.2.2.3 1.5 ml eppendorf tubes, tips and micro-pipettor with the scalar of 10-200 ul are needed.

3.2.1 Aim

3.2.2.4 Vortex or mixture machine is needed.

3.2.1.1 It is easy and quick to obtain purified DNA from mice tail or any tissue after the DNA release within 20 minutes. The ratio of DNA OD260/280 nm is between 1.70-1.90. The purified DNA can be used to run PCR or

3.2.3 The reagents are prepared by you

3.2.3.1 Isopropanol (2-propanol, molecular biology reagent, minimum 99%) is needed. This could be ordered from any chemical company.

3.2.3.2 0.1 x TE buffer that is made by 1/10 of 1 x TE plus 9/10 of distilled water.

To prepared 100 ml of 1 X TE Buffer (pH 7.3) following the below:

Reagents	Final Concentration	Volume	Stock solution
Tris-HCl	10 mM	1.0 ml	1 M Tris-HCl, pH 7.3
EDTA	1 mM	0.2 ml	0.5M EDTA, pH 8.0
Distilled water		98.8 ml	
Total volume		100 ml	



3.2.4 Content Table (Table 3)

Table 3. Ten-minute DNA Release Kit-2 contents table

Catalogue Number	DNA Release Buffer		Work for Samples	Store and Use
	Name	Volume		
JZ-002-1	Kit2-B1	15 ml	100	1.It is qualified fro 6 moths at 5-29? C. 2.Warm to RT before using if it was kept at 4? C.
JZ-002-2	Kit2-B2	6 ml		

3.2.5 Work Table (Table 4)

Table 4. Ten-minute DNA Release Kit-2 work table

Step	Action	Show
Step 1	Place a mouse tail 4-6 mm (or tissue 6-20 mg) in eppendorf tube, add 150 ul of Kit-2 B1 to the tube, as the tube 1. See show 1.	Show 1
Step 2	Put tube 1 at 86°C in a thermo-machine or a water bath, not shaking, for 10 minutes. The 86-90°C is allowed.	
Step 3	Place tube 1 at room temperature (RT) for 2 minutes. Add 60 ul of the Kit-2 B2 to tube 1. Flick the tube 4-6 times (or Vortex 3-5 seconds), then place the tube at RT for 2-3 minutes.	
Step 4	Centrifuge tube 1 at 15,000 g X 3 minutes at RT. Pipette the clear aqueous phase 170 ul from tube 1 to a fresh tube, as tube 2.	
Step 5	Add Isopropanol (2-propanol) 150 ul to tube 2, invert the tube 2 6-10 times. Then, centrifuge it at 15,000g X 3 minutes at RT.	
Step 6	The DNA pellet* should be seen in bottom of the tube 2. Remove the supernatant with micro-pipettor. Then add 1 ml of 70% alcohol to tube 2, wash the DNA pellet by inverting the tube 4-6 times and centrifuge it again, or not.**	Show 2
Step 7	Pour the alcohol out from the Tube 2, then place it on the paper towel to dry the DNA pellet 4-6 minutes at RT. Show 2	
Step 8	Add 32 ul of 0.1X TE buffer to Tube 2. keep it at RT for 8-10 minutes. Flick the tube 6-8 time, the DNA should be dissolved well.	
Step 9	1) To dilute the purified DNA 5-15 times with 0.1 X TE buffer. Then take 1-2 ul as the templet to run PCR in 20-25 reaction volume. 2) To measure the DNA ratio and concentration by Southern blot etc. 3) To keep at 4°C for long time using.	
*	It is easy to see the DNA pellet in the 70% alcohol.	
**	It is unnecessary to centrifuge if the DNA pellet is sticking on bottom of the tube with 70% alcohol.	

3.2.6 Treating for Another Organ Tissue:

3.2.6.1 Cut another organ tissue to 2-3 mm³ (6-20 mg).

3.2.6.2 If the organs tissue is with blood or another dirty trace, please do the following:

3.2.6.2.1 Rinse 2-3 times with PBS without Ca⁺⁺ and Mg⁺⁺.

3.2.6.2.2 Touch dry the tissue on the paper towel. Then, to follow the work table.

3.2.6.3 If the tissue isn't adhered the blood etc., like the clean skin or muscle, it is fine to follow the work table to obtain the desired purified DNA extract.

3.3 Ten-minute DNA Release Kit-3

The Ten-minute DNA Release Kit-3 is for blood-DNA-PCR. The catalogue number is JZ-003.

The preliminary protocol of Ten-minute DNA Release Kit-3 is as the following:

3.3.1 Aim

3.3.1.1 With Ten-minute DNA Release Kit-3 it is easy and quick (5-6 minutes) to obtain desired DNA from blood to run PCR.

3.3.1.2 The DNA could be used for any gene expression to follow your purpose.

3.3.2 Have been ready for the equipments?

3.3.2.1 A room temperature eppendorf centrifuge machine with the speed 10,000-15,000 g setting up.

3.3.2.2 1.5 ml eppendorf tubes, tips and micro-pipettor with the scalar of 10-200 ul.

3.3.2.3 Vortex or mixture machine.



3.3.3 Content Table (Table 5)

Table 5. Ten-minute DNA Release Kit-3 content table

Catalogue Number	DNA Release Buffer		Work for Samples	Store and Use
	Name	Volume		
JZ-003-1	Kit3-B1	1.2 ml	100	1.It is qualified for 6 months at 5-29? C. 2.Warm to RT before using if it was kept at 4? C.
JZ-003-2	Kit3-B2	1.8 ml		
JZ-003-3	Kit3-B3	5.0 ml, 10 X*		

3.3.4 Work Table (Table 6)

Table 6. Ten-minute DNA Release Kit-3 work table

Step	Action	Show
Processing 1, The red blood cells lysis		Show1
Step1	Ready a Eppendorf tube with 500ul of Kit3-B3. Place one drop(15-30ul) of whole blood (heparinized or not) or bone marrow to the tube. Invert it 4-6 times.Centrifuge the tube at 10,000 g x 1 min. in room temperature.	
Step2	The white blood cell pellet with red cells piece(Blood Cells Pellet)should be seen on the tube bottom. With a pipet to remove the red supernatant. Show 1. (If your blood sample is 15 or 20 ul/each. Go ahead from step2 to step4 directly.)	
Step3	Add D.W 500 to the tube. Vortex or flick it 6-8 sec.(times), centrifuge again.	
Step4	Remove the the supernatant as clean as possible. Keep the blood cells pellet in the tube bottom. Show 2.	
Processing 2, 2 minute DNA release		Show1
Step5	Add 12 ul of Kit3-B1 to the tube with the ready blood cells pellet. Flick it until the pellet that was dissolved. And add 18 ul of Kit3-B2 to the tube again.	
Step6	Flick it 3-5 time to be mixed well. The total 30 ul volume has be ready DNA extract. Take 1-3 ul to run PCR in a 20-25 ul reaction volume.	
Note	If using the kit first. It is better for a good experiment result by taking 1-3 ul ready DNA extract to run PCR separately to test the working range on the primer target.	

3.4 Ten-minute DNA Release Kit-4

The Ten-minute DNA Release Kit-4 is for urine-DNA-PCR. Its catalogue number is JZ-004.

The preliminary protocol of Ten-minute DNA Release Kit-1 is as the following:

3.4.1 Aim

3.4.1.1 It is easy and quick from urine to obtain desired DNA to run PCR.

3.4.1.2 The DNA can be used for any gene expression to follow your purpose.

3.4.2 Have been ready for the equipments?

3.4.2.1 It is fine for this kit to have any type of thermo-machine or water bath which can set up the constant temperature between 86-90°C.

3.4.2.2 A room temperature eppendorf centrifuge machine with the speed 10,000-15,000 g.

3.4.2.3 1.5 ml eppendorf tubes, tips and micro-pipettor with the scalar of 10-200 ul.

3.4.2.4 Vortex or mixture machine which is fine to have or have not.

3.4.3 Content Table (Table 7)

Table 7. Ten-minute DNA Release Kit-4 content table

Catalogue Number	DNA Release Buffer		Work for Samples	Store and Use
	Name	Volume		
JZ-004-1	Kit4-B1	1.4 ml	100	1.It is qualified for 6 moths at 5-29°C. 2.Warm to RT before using if it was kept at 4°C.
JZ-004-2	Kit4-B2	2.1 ml		
JZ-004-3	Kit4-B3	5.0 ml, 5 X*		

3.4.4 Work Table (Table 8)

Table 8. Ten-minute DNA Release Kit-4 work table

Processing 1. Collect the urine deposit pellet			
Step	Action	Show	
Step 1	Place urine 1 ml to a eppendorf tube. Add 150 ul of Kit-4 B3 to the tube, mixtured. Centrifuge at 12,000 g X 1 minute.		
Step 2	The urine deposit pellet is in the tube bottom. Remove the supernatant. Add 100 ul of Kit-4 B3 again, resuspend the pellet by flicking or pipette, centrifuge as above.		
Step 3	Remove supernatant and keep pellet in the tube bottom.		
	See show		
Processing 2. 10 Minute DNA release			
Step 4	Add 14 ul of Kit-4 B1 to the tube with urine deposit pellet. Flick it 4-6 time (or vortex). Put it in a thermo-machine or a water bath, not shaking, at 86°C (to 90°C is allowed) for 10 minutes. Then, put it at room temperature for 2 minutes.		
Step 5	Add 21 ul of Kit-4 B2 to the tube, flick it 4-6 times. Centrifuge it at 12,000 g x 3 minutes.		
Step 6	Transfer the supernatant 30-36 ul (DNA is inside) to a fresh eppendorf tube. The desired DNA extract has bee ready. Take 1-3 ul is as the template to run PCR in 20-25 reaction volume.		
Note	If you are first time to use the kit, it is better for the gene expression by trying 1-3 ul separate to run PCR to test the working range for the primers target.		

3.5 Ten-minute DNA Release Kit-5

The Ten-minute DNA Release Kit-5 is for Saliva-DNA-PCR. Its catalogue number is JZ-005.

The preliminary protocol of Ten-minute DNA Release Kit-5 is as the following:

3.5.1 Aim

3.5.1.1 It is easy and quick to obtain desired DNA from saliva to run PCR.

3.5.1.2 The DNA can be used for any gene expression for your purpose.

3.5.2 Have been ready for the equipments?

3.5.2.1 It is fine for this kit to have any type thermo-machine or water bath which can set up the constant temperature between 86-90°C.

3.5.2.2 A room temperature eppendorf centrifuge machine with the speed 10,000-15,000 g.

3.5.2.3 1.5 ml eppendorf tubes, tips and micro-pipettor with the scalar of 10-200 ul.

3.5.2.4 Vortex or mixture machine is fine to have or have not.

3.5.3 The PBS is made by you

Making the 1 X, PBS without Ca⁺⁺ and Mg⁺⁺:

Reagents	1 x, working solution, pH 7.3 ±	Weight
NaCl	137 mM	8.0 g
KCl	2.7 mM	0.2 g
Na ₂ HPO ₄ -7H ₂ O	4.3 mM	1.15 g
KH ₂ PO ₄	1.4 mM	0.2 g

Dissolved in 1000 ml of distilled water.

3.5.4 Content Table (Table 9)

Table 9. Ten-minute DNA Release Kit-5 content table

Catalogue Number	DNA Release Buffer		Work for Samples	Store and Use
	Name	Volume		
JZ-005-1	Kit1-B1	1.4 ml	100	1. It is qualified for 6 moths at 5-29°C. 2.Warm to RT before using if it was kept at 4°C.
JZ-005-2	Kit1-B2	2.1 ml		

3.5.5 Work Table (Table 10)

Table 10. Ten-minute DNA Release Kit-5 work table

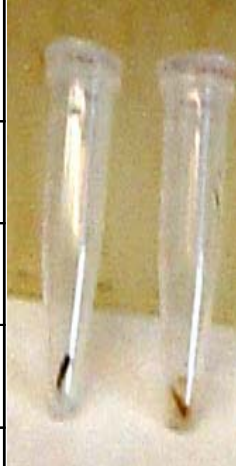
Steps	Action	Show
Step 1	Place a mouse tail 1.5-3 mm, or ear tissue 2x3 mm, (or any tissue and/or material stained the body liquid) to a eppendorf tube. Add 40 ul of Kit-1 B1 to the tube. See show.	
Step 2	Put the tube at 86°C in a Thermo-Mathine or Water Bath, not shaking, for 6-8 minutes (86-90°C is allowed).	
Step 3	Add 60 ul of Kit-1 B2 to the tube, flick it 3-5 times, then keep the tube at room temperature (RT) for 2-3 minutes.	
Step 4	Centrifuge the tube at 15,000 g X 3 minutes. in RT. (The 0-4°C is not allowed).	
Step 5	Pipette the clear aqueous phase 60 ul to a fresh tube, which is the desired DNA extract for PCR. Take 1-3 ul DNA as the templet to run PCR in 20-25 reaction volume.	
Note	If you use the kit first, it's better to do expression on your primer by taking the DNA extract 1-3 to run PCR separately to test the working range.	

3.6 Ten-minute DNA Release Kit-6

Ten-minute DNA Release Kit-6 is for hair follicle-DNA-PCR. Its catalogue number is JZ-006.

The preliminary protocol of Ten-minute DNA Release Kit-1 is as the following:

3.6.1 Aim

3.6.1.1 It is easy and quick to obtain desired DNA from hair follicle to run PCR.

3.6.1.2 The DNA can be used for any gene expression for your purpose.

3.6.2 Have been ready for the equipments?

3.6.2.1 It is fine for this kit to have any type thermo-machine or water bath which could set up the constant temperature between 86-90°C.

3.6.2.2 A room temperature eppendorf centrifuge machine with the speed 10,000-15,000 g.

3.6.2.3 1.5 ml eppendorf tubes, tips and micro-pipette with the scalar 10-200 ul.

3.6.2.4 Vortex or mixture machine which is fine to have or have not.

3.6.3 Content Table (Table 11)

Table 11. Ten-minute DNA Release Kit-6 content table

Catalogue Number	DNA Release Buffer		Work for Samples	Store and Use
	Name	Volume		
JZ-006-1	Kit6-B1	1.2 ml	100	1.It is qualified for 6 moths at 5-29? C. 2.Warm to RT before using if it was kept at 4? C.
JZ-006-2	Kit6-B2	1.8 ml		

3.6.4 Work Table (Table 12)

Table 12. Ten-minute DNA Release Kit-6 work table

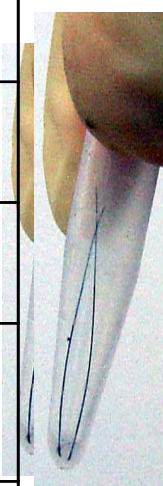
Step	Action	Show
Step 1	Ready an eppendorf with 12 ul of Kit-6 B1. Place hair follicle 2-5 in the buffer. See show.	
Step 2	Put the tube at 86°C in a thermo-machine or water bath, not shaking, for 10 min.	
Step 3	Flick the tube 3-5 times, then keep it at room temperature for 2 minutes.	
Step 4	Add 18 ul of Kit-6 B2 to the tube, flick it again. Throw the follicles out. The 30 ul DNA extract in the tube has been ready.	
Step 5	Take 1-3 ul as the template to run PCR in 20-25 ul reaction volume.	
Note	If you use the kit first time, it is better expression on your primer by taking the DNA extract 1-3 to run PCR separately to test the working range.	

3.7 Ten-minute DNA Release Kit-7

Ten-minute DNA Release Kit-7 is for cells-DNA-PCR and Southern. The catalogue number is JZ-007.

The preliminary protocol of Ten-minute DNA Release Kit-7 is as the following:

3.7.1 Aim

3.7.1.1 It is easy and quick from the adhered culture cells to obtain purified DNA for PCR or Southern.

3.7.1.2 The DNA can be used for any gene expression for your purpose.

3.7.2 Have been ready for the equipments?

3.7.2.1 It is fine for this kit to have any type thermo-machine or water bath which can set up the constant temperature between 86-90°C.

3.7.2.2 A room temperature eppendorf centrifuge machine with the speed 10,000-15,000 g.

3.7.1.3 1.5 ml eppendorf tubes, tips and micro-pipettor with the scalar of 10-200 ul.

3.7.1.4 Vortex or mixture machine which is fine to have or have not.

3.7.3 The PBS is made by yourself

Making the 1X, PBS without Ca⁺⁺ and Mg⁺⁺:

Reagents	1 x, working solution, pH 7.3±	Weight
NaCl	137 mM	8.0 g
KCl	2.7 mM	0.2 g
Na ₂ HPO ₄ -7H ₂ O	4.3 mM	1.15 g
KH ₂ PO ₄	1.4 mM	0.2 g

Dissolved in 1000 ml of distilled water.

3.7.4 Content Table (Table 13)

Table 13. Ten-minute DNA Release Kit-7 content table

Catalogue Number	DNA Release Buffer		Work for Samples	Store and Use
	Name	Volume		1.It is qualified for 6 moths at 5-29? C. 2.Warm to RT before using if it was kept at 4? C.
JZ-007-1	Kit7-B1	1.4 ml	100 times or 40 dishes	
JZ-007-2	Kit7-B2	2.1 ml		

3.7.5 Work Table (Table 14)

Table 14. Ten-minute DNA Release Kit-7 work table

Processing 1 for 5×10^4-1×10^6 of the adhered or suspension cells				
Step	Action			
Step1	The adhered cells are trypsinized and harvested with new growth media. Count and transfer the cells to a eppendorf tube, Centrifuge it at 5000 g X 3 min. remove the supernatant. Add 1 ml of PBS. Centrifuge it again. Remove PBS from the tube, keep cells pellet in the tube bottom.			
Step2	Add 14 ul of Kit7-B1 to the tube. Flick it until the cells pellet that was dissolved. Place the tube at 86? C in a Thermo-machine or Water Bath,not shaking, for 8 min. then, put it at room temperature(RT) for 2 min.			
Step3	Add 21 ul of Kit7-B2 to the tube, mixtured well by flicking 3-5 times. Centrifuge it at 12,000 g X 3 min.in RT.			
Step4	Transfer the supernatant 25-30 ul(DNA is inside) to a fresh eppendorf tube. The DNA extract has been ready for PCR, Southern etc.			
Processing 2 for bigger cells pellet from a 100 mm cell culture dish				
Step	Action			
Step1	The cells Trypsinized. Harvest the cells with Growth Media 5-10 ml to a 10 ml centrifuge tube. Centrifuge the tube at 1000 rpm X 5 min.			
Step2	Get rid of supernatant, add 1 ml of PBS to the the tube. Mixtured with pipettor, then, transfer the PBS with cells to a eppendorf tube.			
Step3	Centrifuge the tube at 5000 g X 5 min. in RT. Remove the PBS and keep the cells pellet in the tube bottom.			
Step4	Add 30 ul of Kit7-B1 to the tube, mixtured well with pipettor.Put it at 86? C in a Thermo- machine of Water Bath, not shaking, for 8 min. then,at RT for 2 min.			
Step5	Add 45 ul of Kit7-B2 to the tube, mixtured well by flicking 3-5 times.			
Step6	Centrifuge it at 12,000 g x 3 min.Transfer the supernatant 70 ul(DNA is inside) to a fresh eppendorf tube. The DNA extract hes been ready for PCR,Southern etc.			
Note	1.you must use the trypsin to digest the adhered cells to obtain the cell pellt . 2.It is not guarantee to have a good DNA extract with scraper to obtain cells. 3.The kit also is using for suspension cells			

4. Reference to the DNA Quantity to Match Your Action (Table 15, Figure 4)

Table 15. Kit-7 DNA quantity on the cell amount dose-dependent effective with adhered cells

Cells	Concentration (ug/ul)		Volume/each	Ratio on 260/280 nm
	Range	Average		
5×10^4	0.12-0.16	0.14	32-36 ul	1.7-2.0
1×10^5	0.22-0.26	0.24	32-36 ul	
5×10^5	0.7-0.9	0.8	32-36 ul	
1×10^6	0.9-1.5	1.2	32-36 ul	
100 mm cell culture dish	1-1.6	1.3	70 ul	
	2.93-2.99	2.96	30 ul	

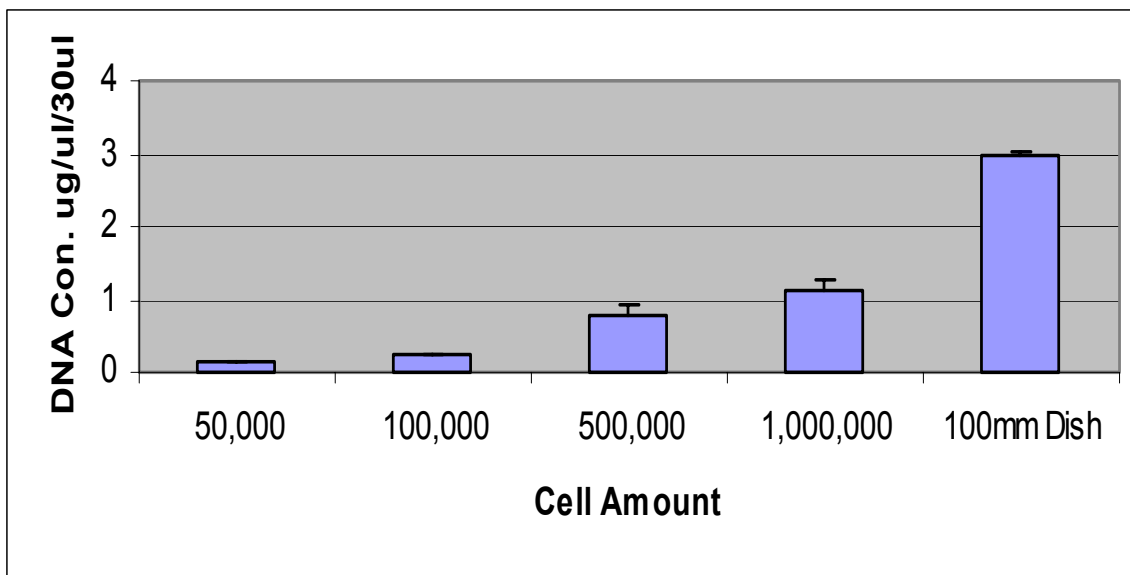

Figure 4. Kit-7 DNA quantity on the cell amount dose-dependent effective with the adhered cells

5. Troubleshooting

If you do not get a good result, please check the process you have done by following:

- 5.1 If the buffers are kept at 5-28° C?
- 5.2 If the sample is frozen sample? The samples must be thawed to the room temperature, then start the process following the protocol.
- 5.3 If you use the centrifuge that is below 4° C? You have to use the centrifuge at room temperature for your good result.
- 5.4 If the buffers are used wrongly?
- 5.5 If you use the incorrect temperature for DNA releasing? You must put the tube at 86-90° C, not shaking in any thermo-machine or water bath.
- 5.6 If the experimental steps are done following the protocol exactly?

References

1. Lee TY, et al. Phylogenetic analysis by RFLP and sequencing of mitochondrial DNA in a Korean Popukation. Arch Oharm Res 2006;29(1):88-95.
2. Chakraborty A, et al. Mplecular identification of hairtail speciec (Pisces: Trichiuridae) base on PCR-RFLP analysis the mitochondrial 16S rRNA gene. J Appl Genet 2005;46(4):381-5.
3. Ren S, et al. A Simplified method to prepare PCR template DNA for screening of transgenic and knockout mice. Contemp Top Lab Anim Sci 2001;40(2):27-30.
4. Hofstetter JR, et al. A comparison of recovery methods and tissue sources. Biochem Mol Med 1997;62(2):197-202.
5. Malumbres M, et al. Isolation of high molecular weight DNA for reliable genotyping of transgenic mice. Bio Techniques 1997;22(6):1114-9.
6. Anderson S, et al. Sequence and organization of human mitochondrial genome. Nature 1981;290(9):457-65.

Correspondence to:

Huaijie Zhu
 Jacksun Easy Biotech Inc.
 2316 Gunther Avenue
 Bronx, NY 10469, USA
 Telephone: (718) 513-0385
 Email: hjz689@yahoo.com; jacksunbio@gmail.com
 Website: www.jacksunbio.com

Wikipedia: The Free Encyclopedia

Ma Hongbao

Department of Medicine, Michigan State University, East Lansing, Michigan, USA. hongbao@msu.edu

Abstract: Wikipedia, the free encyclopedia. It is a stage for all the people in the World to show their opinions/ideas and read other's opinions/ideas freely. Not like most of other publications that claim copyrights and keep readers from free using, Wikipedia claims that "the Wikipedia content can be copied, modified, and redistributed *so long as* the new version grants the same freedoms to others and acknowledges the authors of the Wikipedia article used (a direct link back to the article satisfies our author credit requirement)". [Nature and Science. 2006;4(2):79-91].

Keywords: copyrights; encyclopedia; knowledge; Wikipedia

1. Introduction

By this article, I am introducing the Wikipedia, the free encyclopedia (Wikipedia Foundation, Inc., Wikimedia, 2006). It is a stage for all the people in the World to show their opinions/ideas and read other's opinions/ideas freely. Not like most of other publications that claim copyrights and keep readers from free using, Wikipedia claims that "the Wikipedia content can be copied, modified, and redistributed *so long as* the new version grants the same freedoms to others and acknowledges the authors of the Wikipedia article used (a direct link back to the article satisfies our

author credit requirement)". Is this very benefit to the our human society? Yes, it is! It is good stage for people to show their opinions/works and to get knowledge, and to exchange information.

2. General Information

The following is the general information described by the Wikipedia's official website (Wikipedia Foundation, Inc., Wikimedia, 2006).

2.1 Wikipedia

Wikipedia is the free encyclopedia.

 As a result of recent [vandalism](#), or to stop banned editors from editing, **editing of this page by new or unregistered users is [currently disabled](#)**. Changes can be discussed on the [talk page](#), or you may [request unprotection](#).



Website name	Wikipedia
Commercial?	No
Type of site	Online encyclopedia
Registration	Optional
Owner	Wikimedia Foundation
Created by	Jimmy Wales and Larry Sanger

Wikipedia (IPA: [ˌwɪkiˈpiːdi.ə] or [ˌwiki-]) is an [international Web-based free-content encyclopedia](#). It exists as a [wiki](#), a type of [website](#) that allows visitors to edit its content; the word *Wikipedia* itself is a [portmanteau](#) of *wiki* and *encyclopedia*. Wikipedia is written collaboratively by [volunteers](#), allowing most articles to be changed by anyone with access to a computer, [web browser](#) and [Internet](#) connection.

The project began on [January 15, 2001](#) as a complement to the expert-written (and now defunct) [Nupedia](#), and is now operated by the [non-profit Wikimedia Foundation](#). Wikipedia has more than 3,800,000 articles in many languages, including more than 1,100,000 in the [English-language version](#). Since its inception, Wikipedia has steadily risen in popularity^[1] and has spawned several sister projects.

Wikipedia's most notable style policy is that editors are required to uphold a "neutral point of view", under which notable perspectives are summarized without an attempt to determine an [objective](#) truth.

Wikipedia's co-founder, [Jimmy Wales](#), has called Wikipedia "an effort to create and distribute a

multilingual free encyclopedia of the highest possible quality to every single person on the planet in their own language."^[2] However, there has been controversy over Wikipedia's reliability and accuracy, with the site receiving criticism for its susceptibility to vandalism, uneven quality and inconsistency, [systemic bias](#), and preference of [consensus](#) or [popularity](#) over [credentials](#). Nevertheless, its free distribution, constant updates, diverse and detailed coverage, and numerous multilingual versions have made it one of the most-used reference resources available on the Internet.

There are over 200 language editions of Wikipedia, around 130 of which are active. Fourteen editions have more than 50,000 articles each: [English](#) (the original), [German](#), [French](#), [Polish](#), [Japanese](#), [Dutch](#), [Italian](#), [Swedish](#), [Portuguese](#), [Spanish](#), [Russian](#), [Chinese](#), [Norwegian](#) and [Finnish](#). Its German-language edition has been distributed on [DVD-ROM](#), and there are also proposals for an English DVD or paper edition. Many of its other editions are [mirrored](#) or have been [forked](#) by other websites.

Contents

[\[hide\]](#)

- [1 Characteristics](#)
 - [1.1 Free content](#)
 - [1.2 Language editions](#)
 - [1.3 Editing](#)
- [2 History](#)
- [3 Software and hardware](#)
- [4 Funding](#)
- [5 Evaluations](#)
 - [5.1 Reliability](#)
 - [5.2 Coverage](#)
 - [5.3 Community](#)
 - [5.4 Awards](#)
 - [5.5 Authors](#)
- [6 In popular culture](#)
- [7 See also](#)
- [8 References](#)
- [9 Further reading](#)
- [10 External links](#)

2.2 Characteristics



Wikipedia logo.

2.3 The Wikipedia logo.

Wikipedia's slogan is "the free encyclopedia that anyone can edit," regardless of qualifications. It is developed using a type of [software](#) called a "[wiki](#)", a term originally used for the [WikiWikiWeb](#) and derived from the [Hawaiian](#) *wiki wiki*, which means "quick". Jimmy Wales intends for Wikipedia to ultimately achieve a "[Britannica](#) or better" level of quality and be published in print.

Although several other [encyclopedia projects](#) exist or have existed on the [Internet](#), none have achieved Wikipedia's size or popularity. Traditional multilingual editorial policies and article ownership are sometimes used, such as the expert-written [Stanford Encyclopedia of Philosophy](#), the now-defunct [Nupedia](#), and the more casual [h2g2](#) and [Everything2](#). Projects such as Wikipedia, [Susning.nu](#), [Enciclopedia Libre](#) and [WikiZnatic](#) are other wikis in which articles are developed by numerous authors, and there is no formal process of review. Wikipedia has become the largest such encyclopedic wiki by article and word count. Unlike many encyclopedias, it has licensed its content under the [GNU Free Documentation License](#).

Wikipedia has a set of policies identifying types of information appropriate for inclusion. These policies are often cited in disputes over whether particular content should be added, revised, transferred to a sister project, or removed.

2.4 Free content

The [GNU Free Documentation License](#) (GFDL), the license through which Wikipedia's articles are made available, is one of many "[copyleft](#)" [copyright](#) licenses that permit the redistribution, creation of [derivative works](#), and commercial use of content, provided that its authors are attributed and this content remains available under the GFDL. When an author contributes original material to the project, the copyright over it is retained by them, but they agree to make the work available under the GFDL. Material on Wikipedia may thus be distributed multilingually to, or incorporated from, resources which also use this license.

Wikipedia's content has been mirrored and forked by hundreds of resources from database dumps. Although all text is available under the GFDL, a significant percentage of Wikipedia's images and sounds are not free. Items such as [corporate logos](#), song samples, or copyrighted news photos are used with a claim of [fair use](#).^[3] Wikipedia content has also been used in academic studies, books, conferences, and court cases, albeit much more rarely. For example, the [Parliament of Canada](#) website refers to Wikipedia's article on [same-sex marriage](#) in the "further reading" list of [Civil Marriage Act](#).^[4] Some Wikipedia users, or *Wikipedians*, maintain (noncomprehensive) lists of such uses.^[5]

2.5 Language editions

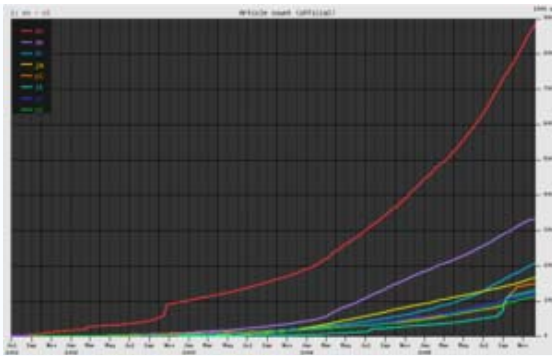

Wikipedia's article count has grown quickly in several of the major language editions.

Wikipedia encompasses 132 "active" language editions (ones with 100+ articles) as of April 2006.^[6] Its five largest editions are, in descending order, [English](#), [German](#), [French](#), [Polish](#) and [Japanese](#). In total, Wikipedia contains 229 language editions of varying states, with a combined 3.5 million articles.^[7]

Language editions operate independently of one another. Editions are not bound to the content of other language editions or direct translations of each other, nor are articles on the same subject required to be translations of each other. Automated translation of articles is explicitly disallowed, though multi-lingual editors of sufficient fluency are encouraged to translate articles by hand. The various language editions *are* held to global policies such as "neutral point of view", though they may diverge on subtler points of policy and practice. Articles and images are shared between Wikipedia editions, the former through "[InterWiki](#)" links and pages to request translations, and the latter through the [Wikimedia Commons](#) repository. Translated articles represent only a small portion of articles in any edition.^[8]

The following is a list of the large editions, sorted by number of articles as of [March 1, 2006](#). (The article

count, however, is a limited metric for comparing the editions. For instance, in some Wikipedia versions nearly half of the articles are short articles created



An example of Wikipedia's range in language editions: Wikipedia in [Hebrew](#). [1]

1. [English](#) (1,068,250)
2. [German](#) (363,360)
3. [French](#) (248,399)
4. [Polish](#) (217,656)
5. [Japanese](#) (187,379)
6. [Dutch](#) (150,461)
7. [Italian](#) (141,234)
8. [Swedish](#) (141,010)
9. [Portuguese](#) (118,697)
10. [Spanish](#) (101,024)
11. [Russian](#) (61,264)
12. [Chinese](#) (58,469)
13. [Norwegian Bokmål](#) (52,392)
14. [Finnish](#) (51,250)
15. [Esperanto](#) (40,968)

2.6 Editing



Editors keep track of changes to articles by checking the difference between two revisions of a page, displayed here in red.

Almost all visitors may edit Wikipedia's content, and registered users can create new articles and have

their changes instantly displayed. Wikipedia is built on the expectation that collaboration among users will improve articles over time, in much the same way that [open-source software](#) develops. Some of Wikipedia's editors have explained its editing process as a "[socially Darwinian evolutionary process](#)",^[1] but this description is not accepted by most Wikipedians.

Although many users take advantage of Wikipedia's [openness](#) to add nonsense to the encyclopedia, most deliberately disruptive edits and comments are quickly found and deleted by other editors. This real-time, collaborative model allow editors to rapidly update existing topics as they develop and to introduce new ones as they arise. However, this collaboration also sometimes leads to "[edit wars](#)" and prolonged disputes when editors do not agree.^[10]



The "recent changes" page shows the newest edits to the English Wikipedia. This page is often watched by users who revert vandalism. There is also a live recent changes [IRC channel](#), [#en.wikipedia](#).

Articles are always subject to editing, unless the article is protected for a short time due to the aforementioned vandalism or revert wars; Wikipedia does not declare any of its articles to be "complete" or "finished". The authors of articles need not have any expertise or formal qualifications in the subjects which they edit, and users are warned that their contributions may be "edited mercilessly and redistributed at will" by anyone who wishes to do so. Its articles are not controlled by any particular user or editorial group; decisions on the content and editorial policies of Wikipedia are instead made largely through [consensus decision-making](#) and, occasionally, by vote. [Jimmy Wales](#) retains final judgement on Wikipedia policies and user guidelines.^[11]

Regular users often maintain a "watchlist" of articles of interest to them, so that they can easily keep tabs on all recent changes to those articles, including new updates, discussions, and vandalism. Most past edits to Wikipedia articles also remain viewable after

the fact, and are stored on "edit history" pages sorted chronologically, making it possible to see former versions of any page at any time. The only exceptions are the entire histories of articles which have been deleted, and many individual edits which contain [libelous](#) statements, copyright violations, and other content which could incur legal liability or be otherwise detrimental to Wikipedia; these edits may only be viewed by Wikipedia administrators.

2.7 History

Main article: [History of Wikipedia](#)

Wikipedia originally developed out of another encyclopedia project, Nupedia.

Wikipedia began as a complementary project for [Nupedia](#), a free online encyclopedia project whose articles were written by experts through a formal process. Nupedia was founded on [March 9, 2000](#) under the ownership of [Bomis, Inc](#), a Web portal company. Its principal figures were [Jimmy Wales](#), Bomis CEO, and [Larry Sanger](#), editor-in-chief for Nupedia and later Wikipedia. Nupedia was described by Sanger as differing from existing encyclopedias in being [open content](#), in not having size limitations, as it was on the [Internet](#), and in being free of bias, due to its public nature and potentially broad base of contributors.^[12] Nupedia had a seven-step review process by appointed subject-area experts, but later came to be viewed as too slow for producing a limited number of articles. Funded by Bomis, there were initial plans to recoup its investment by the use of advertisements.^[12] It was initially licensed under its own Nupedia Open Content License, switching to the GNU Free Documentation License prior to Wikipedia's founding at the urging of [Richard Stallman](#).

On [January 10, 2001](#), Larry Sanger proposed on the Nupedia mailing list to create a wiki alongside Nupedia. Under the subject "Let's make a wiki", he wrote:

No, this is not an indecent proposal. It's an idea to add a little feature to Nupedia. Jimmy Wales thinks that many people might find the idea objectionable, but I think not. (...) As to Nupedia's use of a wiki, this is the ULTIMATE "open" and simple format for developing content. We have occasionally bandied about ideas for simpler, more open projects

to either replace or supplement Nupedia. It seems to me wikis can be implemented practically instantly, need very little maintenance, and in general are very low-risk. They're also a potentially great source for content. So there's little downside, as far as I can see.^[13]

Wikipedia was formally launched on [January 15, 2001](#), as a single English-language edition at <http://www.wikipedia.com>, and announced by Sanger on the Nupedia mailing list.^[14] It had been, from January 10, a feature of Nupedia.com in which the public could write articles that could be incorporated into Nupedia after review. It was relaunched off-site after Nupedia's Advisory Board of subject experts disapproved of its production model.^[15] Wikipedia thereafter operated as a standalone project without control from Nupedia. Its policy of "neutral point-of-view" was codified in its initial months, though it is similar to Nupedia's earlier "nonbias" policy. There were otherwise few rules initially. Wikipedia gained early contributors from Nupedia, [Slashdot](#) postings, and [search engine](#) indexing. It grew to approximately 20,000 articles, and 18 language editions, by the end of its first year. It had 26 language editions by the end of 2002, 46 by the end of 2003, and 161 by the end of 2004.^[16] Nupedia and Wikipedia coexisted until the former's servers went down, permanently, in 2003, and its text was incorporated into Wikipedia.



Wikipedia's English edition on [March 30, 2001](#), two and a half months after its founding.

Wales and Sanger attribute the concept of using a wiki to [Ward Cunningham's](#) WikiWikiWeb or [Portland Pattern Repository](#). Wales mentioned that he heard the concept first from Jeremy Rosenfeld, an employee of Bomis who showed him the same wiki, in December

2000,^[17] but it was after Sanger heard of its existence in January 2001 from Ben Kovitz, a regular at the wiki,^[15] that he proposed the creation of a wiki for Nupedia to Wales and Wikipedia's history started. Under a similar concept of free content, though not wiki-based production, the [GNUpedia](#) project existed alongside Nupedia early in its history. It subsequently became inactive, and its creator, [free-software](#) figure [Richard Stallman](#), lent his support to Wikipedia.^[18]

Citing fears of commercial advertising and lack of control in a perceived English-centric Wikipedia, users of the [Spanish Wikipedia](#) forked from Wikipedia to create the [Enciclopedia Libre](#) in February 2002. Later that year, Wales announced that Wikipedia would not display [advertisements](#), and its website was moved to wikipedia.org. Various other projects have since forked from Wikipedia for editorial reasons, such as [Wikinfo](#), which abandoned "neutral point-of-view" in favor of multiple complementary articles written from a "sympathetic point-of-view".

The Wikimedia Foundation was created from Wikipedia and Nupedia on [June 20, 2003](#).^[19] Wikipedia and its sister projects thereafter operated under this [non-profit organization](#). Wikipedia's first sister project, "In Memoriam: September 11 Wiki", had been created in October 2002 to detail the [September 11, 2001 attacks](#); [Wiktionary](#), a dictionary project, was launched in December 2002; [Wikiquote](#), a collection of quotations, a week after Wikimedia launched; and [Wikibooks](#), a collection of collaboratively-written free books, the next month. Wikimedia has since started a number of other projects, detailed below.

Wikipedia has traditionally measured its status by article count. In its first two years, it grew at a few hundred or fewer new articles per day; by 2004, this had accelerated to a total of 1,000 to 3,000 per day (counting all editions). The English Wikipedia reached its 100,000-article milestone on [January 22, 2003](#)^[20]. Wikipedia reached its one millionth article, among the 105 language editions that existed at the time, on [September 20, 2004](#),^[21] while the English edition alone reached its 500,000th on [March 18, 2005](#).^[22] This figure had doubled less than a year later, with the millionth article in the English edition being created on [March 1, 2006](#)^[23]; meanwhile, the millionth user registration had been made just 2 days before.

The Wikimedia Foundation applied to the [United States Patent and Trademark Office](#) to [trademark Wikipedia®](#) on [September 17, 2004](#). The mark was granted registration status on [January 10, 2006](#). Trademark protection was accorded by [Japan](#) on [December 16, 2004](#) and in the [European Union](#) on [January 20, 2005](#). Technically a [service mark](#), the scope of the mark is for: "Provision of [information](#) in the field of general encyclopedic knowledge via the [Internet](#)".

There are currently plans to license the usage of the Wikipedia trademark for some products, such as books or DVDs.^[24] The [German Wikipedia](#) will be printed in its entirety by Directmedia, in 100 volumes of 800 pages each, beginning in October 2006, and publishing will finish in 2010.

2.8 Software and hardware



Wikipedia receives over 2000 page requests per second. More than 100 servers have been set up to handle the traffic.

Wikipedia is run by [MediaWiki free software](#) on a cluster of dedicated servers located in [Florida](#) and four other locations around the world. MediaWiki is Phase III of the program's software. Originally, Wikipedia ran on [UseModWiki](#) by [Clifford Adams](#) (Phase I). At first it required [CamelCase](#) for links; later it was also possible to use double brackets. Wikipedia began running on a [PHP wiki engine](#) with a [MySQL database](#) in January 2002. This software, Phase II, was written specifically for the Wikipedia project by [Magnus Manske](#). Several rounds of modifications were made to improve performance in response to increased demand. Ultimately, the software was rewritten again, this time by Lee Daniel Crocker. Instituted in July 2002, this Phase III software was called MediaWiki. It was licensed under the [GNU General Public License](#) and used by all Wikimedia projects.



Some Wikimedia servers.

Wikipedia was served from a single server until 2003, when the server setup was expanded into a distributed [multitier architecture](#). In January 2005, the project ran on 39 dedicated servers located in Florida. This configuration included a single master database server running [MySQL](#), multiple slave database servers, 21 web servers running the [Apache](#) software, and seven [Squid cache](#) servers. By September 2005, its server cluster had grown to around 100 servers in four locations around the world.

Page requests are processed by first passing to a front-end layer of [Squid caching](#) servers. Requests that cannot be served from the Squid cache are sent to two load-balancing servers running the [Perlbal](#) software, which then pass the request to one of the Apache web servers for page-rendering from the database. The web servers serve pages as requested, performing page rendering for all the Wikipedias. To increase speed further, rendered pages for anonymous users are cached in a filesystem until invalidated, allowing page rendering to be skipped entirely for most common page accesses. Wikimedia has begun building a global network of [caching servers](#) with the addition of three such servers in [France](#). A new Dutch cluster is also online now. In spite of all this, Wikipedia page load times remain quite variable. The ongoing status of Wikipedia's website is posted by users at a [status page](#) on [OpenFacts](#).

2.9 Funding

Wikipedia is funded through the [Wikimedia Foundation](#). Its 4th Quarter 2005 costs were \$321,000 with hardware making up almost 60% of the budget.^[25]

[Bomis](#), an online advertising company that hosts mostly adult-oriented web-rings, played a significant part in the early development of Wikipedia and the network itself.

2.10 Evaluations

Further information: [Criticism of Wikipedia](#)

Wikipedia has become increasingly controversial as it has gained prominence and popularity, with many critics alleging that Wikipedia's open nature makes it unauthoritative and unreliable, that it exhibits severe [systemic bias](#) and inconsistency, and that the [group dynamics](#) of its community are hindering its goals. Wikipedia has also been criticized for its use of dubious sources, its disregard for credentials, and its vulnerability to vandalism and special interest groups. Critics of Wikipedia include Wikipedia editors themselves, ex-editors, representatives of other encyclopedias, and even subjects of articles.

2.11 Reliability

Wikipedia has been both praised and criticized for being open to editing by anyone. Proponents contend that open editing improves quality over time, while critics allege that non-expert editing undermines quality.

Wikipedia has been criticized for a perceived lack of reliability, comprehensiveness, and authority. It is considered to have no or limited utility as a [reference work](#) among many [librarians](#), [academics](#), and the [editors](#) of more formally written encyclopedias. Many university lecturers discourage their students from using any encyclopedia as a reference in academic work, preferring primary sources instead.^[26] A website called Wikipedia Watch has been created to denounce Wikipedia as having "...a massive, unearned influence on what passes for reliable information."^[27]

Some argue that allowing anyone to edit makes Wikipedia an unreliable work. Wikipedia contains no formal [peer review](#) process for fact-checking, and the editors themselves may not be well-versed in the topics they write about. In a 2004 interview with *The Guardian*, librarian Philip Bradley said that he would not use Wikipedia and is "not aware of a single librarian who would. The main problem is the lack of authority. With printed publications, the publishers have to ensure that their data are reliable, as their livelihood depends on it. But with something like this, all that goes out the window" (Waldman, 2004). Similarly, *Encyclopædia Britannica's* executive editor, Ted Pappas, was quoted in *The Guardian* as saying: "The premise of Wikipedia is that continuous improvement will lead to perfection. That premise is completely unproven."^[28] On [October 24, 2005](#), *The Guardian* published an article "[Can you trust Wikipedia?](#)" where a group of experts critically reviewed entries for their fields. Discussing Wikipedia as an academic source, [Danah Boyd](#) said in 2005 that "[i]t will never be an encyclopedia, but it will contain extensive knowledge that is quite valuable for different purposes".^[29]

Academic circles have not been exclusively dismissive of Wikipedia as a reference. Wikipedia articles have been referenced in "enhanced perspectives" provided on-line in *Science*. The first of these perspectives to provide a hyperlink to Wikipedia was "A White Collar Protein Senses Blue Light" (Linden, 2002), and dozens of enhanced perspectives have provided such links since then. However, these links are offered as background sources for the reader, not as sources used by the writer, and the "enhanced perspectives" are not intended to serve as reference material themselves.

Some critics have suggested that Wikipedia cannot justifiably be called an "encyclopedia", a term which (it is claimed) implies a high degree of reliability and authority that Wikipedia, due to its open editorial

policies, may not be able to maintain. However, Wikipedia does meet all the criteria for the basic definition of the word *encyclopedia*.

In a 2004 piece called "The Faith-Based Encyclopedia," former *Britannica* editor [Robert McHenry](#) criticized the wiki approach, writing,

[h]owever closely a Wikipedia article may at some point in its life attain to reliability, it is forever open to the uninformed or semiliterate meddler... The user who visits Wikipedia to learn about some subject, to confirm some matter of fact, is rather in the position of a visitor to a public restroom. It may be obviously dirty, so that he knows to exercise great care, or it may seem fairly clean, so that he may be lulled into a false sense of security. What he certainly does not know is who has used the facilities before him.^[30]

In response to this criticism, proposals have been made to provide various forms of provenance for material in Wikipedia articles; see for example [Wikipedia:Provenance](#). The idea is to provide *source provenance* on each interval of text in an article and *temporal provenance* as to its vintage. In this way a reader can know "who has used the facilities before him" and how long the community has had to process the information in an article to provide calibration on the "sense of security". However, these proposals for provenance are quite controversial. Aaron Krowne wrote a rebuttal article in which he criticized McHenry's methods, and labeled them "FUD," the marketing technique of "fear, uncertainty, and doubt."^[31]

Former [Nupedia](#) editor-in-chief [Larry Sanger](#) criticized Wikipedia in late 2004 for having, according to Sanger, an "anti-elitist" philosophy of active contempt for expertise.^[32]

The English-language website also suffers from frequent timeouts, server errors and occasional [downtime](#) due to heavy user traffic. These problems have had a negative impact on Wikipedia's desired image as a fast and reliable source of information.

At the end of [2005](#), [controversy erupted](#) after journalist [John Seigenthaler Sr.](#) found that his biography had been written largely as a hoax about Seigenthaler. This led to the decision to restrict the ability to start articles to registered users.

2.12 Coverage



"Be Bold" has become an unofficial slogan of Wikipedia.

Wikipedia's editing process assumes that exposing an article to many users will result in accuracy. Referencing [Linus' law](#) of open-source development, Sanger stated earlier: "Given enough eyeballs, all errors are shallow."^[33] Technology figure [Joi Ito](#) wrote on Wikipedia's authority, "[a]lthough it depends a bit on the field, the question is whether something is more likely to be true coming from a source whose resume sounds authoritative or a source that has been viewed by hundreds of thousands of people (with the ability to comment) and has survived."^[34] Conversely, in an informal test of Wikipedia's ability to detect misinformation, its author remarked that its process "isn't really a fact-checking mechanism so much as a voting mechanism", and that material which did not appear "blatantly false" may be accepted as true.^[35]

Wikipedia has been accused of deficiencies in comprehensiveness because of its voluntary nature, and of reflecting the systemic biases of its contributors. *Encyclopædia Britannica* editor-in-chief Dale Hoiberg has argued that "people write of things they're interested in, and so many subjects don't get covered; and news events get covered in great detail. The entry on [Hurricane Frances](#) was five times the length of that on [Chinese art](#), and the entry on [Coronation Street](#) was twice as long as the article on [Tony Blair](#)."^[28] (As of December 2005, this is no longer the case.) Former Nupedia editor-in-chief Larry Sanger stated in 2004, "when it comes to relatively specialized topics (outside of the interests of most of the contributors), the project's credibility is very uneven."^[32]

Wikipedia has been praised for making it possible for articles to be updated or created in response to current events. For example, the then-new article on the [2004 Indian Ocean earthquake](#) on its English edition was cited often by the press shortly after the incident. Its editors have also argued that, as a website, Wikipedia is

able to include articles on a greater number of subjects than print encyclopedias may.^[36]

[Microsoft Encarta](#) has started to solicit comments from readers in attempt to improve the accuracy and timeliness of its encyclopedia. [Encarta Feedback](#) allows any user to propose revisions for review by their staff.^[37]

The German computing magazine *c't* performed a comparison of [Brockhaus Multimedial](#), [Microsoft Encarta](#), and Wikipedia in October 2004: Experts evaluated 66 articles in various fields. In overall score, Wikipedia was rated 3.6 out of 5 points ("B-"), *Brockhaus Premium* 3.3, and *Microsoft Encarta* 3.1.^[38] In an analysis of online encyclopedias, [Indiana University](#) professors Emigh and Herring wrote that "Wikipedia improves on traditional information sources, especially for the content areas in which it is strong, such as technology and current events."^[39] The [journal Nature](#) reported in 2005 that [science](#) articles in Wikipedia were comparable in accuracy to those in *Encyclopedia Britannica*. Wikipedia had an average of four mistakes per article; Britannica contained three. Of eight "serious errors" found — including misinterpretations of important concepts — four came from each source.^[40] On March 24, 2006, Britannica provided a rebuttal labeling the study "fatally flawed".^[41]

2.13 Community

The [Wikipedia community](#) consists of users who are proportionally few, but highly active. Emigh and Herring argue that "a few active users, when acting in concert with established norms within an open editing system, can achieve ultimate control over the content produced within the system, literally erasing diversity, controversy, and inconsistency, and homogenizing contributors' voices."^[42] Editors on [Wikinfo](#), a [fork](#) of Wikipedia, similarly argue that new or controversial editors to Wikipedia are often unjustly labeled "[trolls](#)" or "problem users" and blocked from editing.^[43] Its community has also been criticized for responding to complaints regarding an article's quality by advising the complainer to fix the article.^[44]

In a page on researching with Wikipedia, its authors argue that Wikipedia is valuable for being a social community. That is, authors can be asked to defend or clarify their work, and disputes are readily seen.^[45] Wikipedia editions also often contain [reference desks](#) in which the community answers questions.

2.14 Awards

Wikipedia won two major awards in May 2004^[46]. The first was a Golden Nica for Digital Communities, awarded by [Prix Ars Electronica](#); this came with a 10,000 [euro](#) grant and an invitation to present at the PAE Cyberarts Festival in [Austria](#) later that year. The

second was a Judges' [Webby award](#) for the "community" category. Wikipedia was also nominated for a "Best Practices" Webby. In September 2004, the [Japanese Wikipedia](#) was awarded a Web Creation Award from the Japan Advertisers Association. This award, normally given to individuals for great contributions to the Web in Japanese, was accepted by a long-standing contributor on behalf of the project. Wikipedia has received plaudits from sources including [BBC News](#), [Washington Post](#), [The Economist](#), [Newsweek](#), [Los Angeles Times](#), [Science](#), [The Guardian](#), [Chicago Sun-Times](#), [The Times](#) (London), [Toronto Star](#), [Globe and Mail](#), [The Financial Times](#), [Time Magazine](#), [Irish Times](#), [Reader's Digest](#) and [The Daily Telegraph](#).

2.15 Authors

During December 2005, Wikipedia had about 27,000 users who made at least five edits that month; 17,000 of these active users worked on the English edition.^[47] A more active group of about 4,000 users made more than 100 edits per month, over half of these users having worked in the English edition. According to Wikimedia, one-quarter of Wikipedia's traffic comes from users without accounts, who are less likely to be editors.^[48]

Maintenance tasks are performed by a group of volunteer developers, stewards, bureaucrats, and administrators, which number in the hundreds. Administrators are the largest such group, privileged with the ability to prevent articles from being edited, delete articles, or block users from editing in accordance with community policy. Many users have been temporarily or permanently blocked from editing Wikipedia. Vandalism or the minor infraction of policies may result in a warning or temporary block, while long-term or permanent blocks for prolonged and serious infractions are given by [Jimmy Wales](#) or, on its English edition, an elected Arbitration Committee.

Former Nupedia editor-in-chief [Larry Sanger](#) has said that having the [GFDL](#) license as a "guarantee of freedom is a strong motivation to work on a free encyclopedia."^[49] In a study of Wikipedia as a community, economics professor [Andrea Ciffolilli](#) argued that the low [transaction costs](#) of participating in [wiki](#) software create a catalyst for collaborative development, and that a "creative construction" approach encourages participation.^[50] Wikipedia has been viewed as a social experiment in [anarchy](#), [democracy](#), or [communism](#). Its founder has replied that it is not intended as one, though that is a consequence.^[51] Critics of Wikipedia have also viewed it as an [oligarchy](#) which is controlled primarily by its [administrators](#), [stewards](#), and [bureaucrats](#), or simply by a small number of its contributors. [Daniel Brandt](#) of [Wikipedia Watch](#) has referred to [Jimbo Wales](#) as the "[dictator](#)" of Wikipedia; however, most [Wikipedia users](#)

either do not consider Wales to be a dictator, or consider him to be one who rarely gives non-negotiable orders.^[2]

2.16 In popular culture

Wikipedia is parodied at several websites, including [Encyclopedia Dramatica](#) and [Uncyclopedia](#). [Webster's Dictionary](#) has been parodied as **Webster's Wikipedia** on the [flash clip](#) *Masters of Doom: The Animated Series*.

The [May 7, 2005 FoxTrot comic strip](#) showed one character [appending](#) his older sister to unflattering Wikipedia articles. In a similar joke, the web comic *Penny Arcade* also [satirized](#) Wikipedia with a [comic strip](#) depicting [Skeleton](#) vandalizing the [He-Man](#) article.

The following the copyrights information from official website of Wikipedia (Wikimedia Foundation, Inc. Wikipedia Copyrights, 2006).

3. Copyrights

3.1 Wikipedia: Copyrights (From Wikipedia, the free encyclopedia)

The license [Wikipedia](#) uses grants free access to our content in the same sense as [free software](#) is licensed freely. This principle is known as [copyleft](#). That is to say, Wikipedia content can be copied, modified, and redistributed *so long as* the new version grants the same freedoms to others and acknowledges the authors of the Wikipedia article used (a direct link back to the article satisfies our author credit requirement). Wikipedia articles therefore will remain free forever and can be used by anybody subject to certain restrictions, most of which serve to ensure that freedom.

To fulfill the above goals, the text contained in Wikipedia is licensed to the public under the [GNU Free Documentation License](#) (GFDL). The full text of this license is at [Wikipedia:Text of the GNU Free Documentation License](#).

Permission is granted to copy, distribute and/or modify this document under the terms of the GNU Free Documentation License, Version 1.2 or any later version published by the [Free Software Foundation](#); with no Invariant Sections, with no Front-Cover Texts, and with no Back-Cover Texts.

A copy of the license is included in the section entitled "[GNU Free Documentation License](#)".

Content on Wikipedia is covered by [disclaimers](#).

The English text of the GFDL is the only legally binding document; what follows is our interpretation of the GFDL: the rights and obligations of users and contributors.

IMPORTANT: If you want to use content from Wikipedia, first read the [Users' rights and obligations](#) section. You should then read the [GNU Free Documentation License](#).

Contents

- [1 Users' rights and obligations](#)
- [1.1 Example notice](#)
- [1.2 Fair use materials and special requirements](#)
- [2 Image guidelines](#)
- [2.1 Tagging](#)
- [2.2 U.S. government photographs](#)
- [2.3 UK Crown Copyright](#)
- [2.4 Celebrity photographs](#)
- [3 Comments on copyright laws by country](#)
- [3.1 Russia: copyright exemptions](#)
- [3.2 Algeria](#)
- [3.3 Iran](#)
- [4 Contributors' rights and obligations](#)
- [4.1 Introducing invariant sections or cover texts in wikipedia](#)
- [4.2 Using copyrighted work from others](#)
- [4.3 Linking to copyrighted works](#)
- [4.4 If you find a copyright infringement](#)
- [5 If you are the owner of Wikipedia-hosted content being used without your permission](#)
- [6 See also](#)

3.2 Users' rights and obligations

If you want to use Wikipedia materials in your own books/articles/web sites or other publications, you can do so, but you have to follow the GFDL. If you are simply duplicating the Wikipedia article, you must follow [section two](#) of the GFDL on *verbatim copying*, as discussed at [Wikipedia:Verbatim copying](#).

If you create a derivative version by changing or adding content, this entails the following:

- your materials in turn have to be licensed under GFDL,

- you must acknowledge the authorship of the article (section 4B), and

- you must provide access to the "transparent copy" of the material (section 4J). (The "transparent copy" of a Wikipedia article is any of a number of formats available from us, including the wiki text, the html web pages, xml feed, etc.)

You may be able to partially fulfill the latter two obligations by providing a conspicuous direct link back to the Wikipedia article hosted on this website. You also need to provide access to a transparent copy of the new text. However, please note that the Wikimedia Foundation makes no guarantee to retain authorship information and a transparent copy of articles. Therefore, you are encouraged to provide this authorship information and a transparent copy with your derived works.

3.3 Example notice

An example notice, for an article that uses the Wikipedia article [Metasyntactic variable](#) might read as follows:

```
This article is licensed under the <a href="http://www.gnu.org/copyleft/fdl.html">GNU Free Documentation License</a>. It uses material from the <a href="http://en.wikipedia.org/wiki/Metasyntactic_variable">Wikipedia article "Metasyntactic variable"</a>. ("Metasyntactic variable" and the Wikipedia URL must of course be substituted accordingly.)
```

Alternatively you can distribute your copy of "Metasyntactic variable" along with a copy of the GFDL (as explained in the text) and list at least five (or all if fewer than five) principal authors on the title page (or top of the document). The external [Page History Stats](#) tool can help you identify the principal authors.

3.4 Fair use materials and special requirements

All original Wikipedia text is distributed under the [GFDL](#). Occasionally, Wikipedia articles may include images, sounds, or text quotes used under the U.S. Copyright law "[fair use](#)" doctrine. It is preferred that these be obtained under the most free ([libre](#)) license (such as the GFDL or public domain) practical. In cases where no such images/sounds are currently available,

then fair use images are acceptable (until such time as free images become available).

In *Wikipedia*, such "fair use" material should be identified as from an external source (on the image description page, or history page, as appropriate). This also leads to possible restrictions on the use, outside of Wikipedia, of such "fair use" content retrieved from Wikipedia: this "fair use" content does not fall under the GFDL license as such, but under the "fair use" (or similar/different) regulations in the country where the media are retrieved.

Wikipedia does use some text under licenses that are compatible with the GFDL but may require additional terms that we do not require for original Wikipedia text (such as including Invariant Sections, Front-Cover Texts, or Back-Cover Texts). When wanting to contribute such texts that include Invariant Sections or Cover Texts to Wikipedia, see [Introducing invariant sections or cover texts in wikipedia](#) below.

3.5 Image guidelines

Images and photographs, like written works, are subject to [copyright](#). Someone owns them unless they have been explicitly placed in the [public domain](#). Images on the internet need to be licensed directly from the copyright holder or someone able to license on their behalf. In some cases, [fair use](#) guidelines may allow a photograph to be used.

3.6 Tagging

Image description pages can be tagged with a special tag to indicate the legal status of the images, as described at [Wikipedia:Image copyright tags](#). It is currently unclear what should happen in cases where the same image has been uploaded more than once with different respective copyright statements.

3.7 U.S. government photographs

Works produced by civilian and military employees of the [United States](#) federal government in the scope of their employment are public domain by statute. However, note that, despite popular misconception, the U.S. Federal Government can own copyrights that are assigned to it by others (for example, works created by contractors). Be careful, however: not all images on .mil and .gov websites are public domain. Among other reasons, the site may be using commercial [stock photography](#) owned by others. It may be useful to check the privacy and security notice of the website, but only with an email to the webmaster can you be confident that an image is in the public domain. It should also be noted that governments outside the U.S. often do claim copyright over works produced by their employees (for example, [Crown Copyright](#) in the [United Kingdom](#)). Also, most state and local governments in the United States do not place their work into the public domain

and do in fact own the copyright to their work. Please be careful to check ownership information before copying.

3.8 UK Crown Copyright

The UK [Office of Public Sector Information](#), formerly [HMSO](#), has told us:

[Crown copyright](#) protection in published material lasts for fifty years from the end of the year in which the material was first published. Therefore [for example] material published [fifty-one years ago], and any Crown copyright material published before that date, would now be out of copyright, and may be freely reproduced throughout the world. [1]

3.9 Celebrity photographs

This is based on the image guidelines at [IMDB](#), so it especially applies to celebrity photographs, but also can apply to other pictures. Legitimate photographs generally come from three different places **with permission**.

The studios, producers, magazine publisher, or media outlet that originally shot the photograph.

Agencies that represent the photographers who shot the photos or the photographer themselves (the latter especially for amateur photographs)

Submissions from the celebrity himself or herself or a legal representative of the celebrity.

Comments on copyright laws by country

3.10 Russia: copyright exemptions

According to the Russian copyright law of 1993 ([Федеральный закон от 9.07.1993 № 5351-1](#)), the following items are not subject to copyrights:

Official documents (laws, court decisions, other texts of legislative, administrative or judicial character);

State symbols and tokens (flags, coats of arms, [orders](#), banknotes and other state symbols and tokens);

Folk creative works;

Reports about events and facts, of informative character.

Russian copyrights generally expire in 70 years after the death of the author. Items by authors who died prior to 1953 are public domain, because the expiration term was 50 years before 2004, and this change of the term wasn't retroactive, according to [Law 72-FZ, 2004 \(in Russian\)](#), article 2, part 3).

If an item was not published during author's life, its copyright expire in 70 years after its first lawful publication (if the item wasn't moved into [PD](#) before). This gives maximum term for unpublished or posthumously published works of 140 (if the author died after 1953) or 120 years (if the author died before 1953, AND his work was published before 2003).

If an item was published anonymously or pseudonymously, and its author remains unknown, its

copyright expires in 70 years after its first lawful publication. If the author is discovered, usual rule applies.

PD status of a work in Russia can differ with that in the US, where Wikipedia servers are located.

3.11 Algeria

Article 9 of Algeria's [Ordonnance N°97-10 du 27 Chaoual 1417 correspondant au 6 mars 1997 relative aux droits d'auteur et aux droits voisins](#), states that: "Works of the State made licitly accessible to the public may be freely used for non-profit purposes, subject to respect for the integrity of the work and indication of its source. By "works of the State", in this article, are meant works produced and published by the various organs of the State, local communities, or public establishments of an administrative character." (original is in French.) In short, they are available for non-commercial use - which is deprecated on Wikipedia.

3.12 Iran

Although there has been no treaty between Iran and the United States regarding copyright protection, according to [Jimbo Wales](#), Wikipedia contributors should respect Iranian copyright law as best they can, the same as they do for other countries around the world. [\[2\]](#)

3.13 Contributors' rights and obligations

If you contribute material to Wikipedia, you thereby license it to the public under the GFDL (with no invariant sections, front-cover texts, or back-cover texts). In order to contribute, you therefore must be in a position to grant this license, which means that either

you own the copyright to the material, for instance because you produced it yourself, or

you acquired the material from a source that allows the licensing under GFDL, for instance because the material is in the [public domain](#) or is itself published under GFDL.

In the first case, you retain copyright to your materials. You can later republish and relicense them in any way you like. However, you can never retract the GFDL license for the versions you placed here: that material will remain under GFDL forever.

In the second case, if you incorporate external GFDL materials, as a requirement of the GFDL, you need to acknowledge the authorship and provide a link back to the network location of the original copy.

Introducing invariant sections or cover texts in wikipedia

Under Wikipedia's current copyright conditions, and with the current facilities of the MediaWiki software, it is not possible to place external GFDL materials that contain invariant sections or cover texts in Wikipedia, unless all of the following applies,

You are the copyright holder of these external GFDL materials (or: you have the explicit, i.e. written, permission of the copyright holder to do what follows);

The length and nature of these invariant sections and cover texts does not exceed what can be placed in an [edit summary](#);

You are satisfied that these invariant sections and cover texts are not listed elsewhere than in the "page history" of the page where these external materials are placed;

You are satisfied that further copies of Wikipedia content are distributed under the standard GFDL application of "with no Invariant Sections, with no Front-Cover Texts, and with no Back-Cover Texts" (in other words, for the copies derived from wikipedia, you agree that these parts of the text contributed by you will no longer be considered as "invariant sections" or "cover texts" in the GFDL sense);

The original invariant sections and/or cover texts are contained in the edit summary of the edit with which you introduce the thus GFDLed materials in wikipedia (so, that if "permanent deletion" would be applied to that edit, both the thus GFDLed material and its invariant sections and cover texts are jointly deleted).

Seen the stringent conditions above, it is very desirable to replace GFDL texts with invariant sections (or with cover texts) by original content without invariant sections (or cover texts) whenever possible.

Using copyrighted work from others

If you use part of a copyrighted work under "[fair use](#)", or if you obtain special permission to use a copyrighted work from the copyright holder under the terms of our license, you must make a note of that fact (along with names and dates). It is our goal to be able to freely redistribute as much of Wikipedia's material as possible, so original images and sound files licensed under the GFDL or in the [public domain](#) are greatly preferred to copyrighted media files used under fair use. See [Wikipedia:Boilerplate request for permission](#) for a form letter asking a copyright holder to grant us a license to use their work under terms of the GFDL.

Never use materials that infringe the copyrights of others. This could create legal liabilities and seriously hurt the project. If in doubt, write it yourself.

Note that copyright law governs the *creative expression* of ideas, not the ideas or information themselves. Therefore, it is legal to read an encyclopedia article or other work, reformulate the concepts in your own words, and submit it to Wikipedia. However, it would still be unethical (but not illegal) to do so without citing the original as a reference. See [plagiarism](#) and [fair use](#) for discussions of how much reformulation is necessary in a general context.

3.14 Linking to copyrighted works

Linking to copyrighted works is usually not a problem, as long as you have made a reasonable effort to determine that the page in question is not violating *someone else's* copyright. If it is, please do *not* link to the page. Whether such a link is contributory infringement is currently being debated in the courts, but in any case, linking to a site that illegally distributes someone else's work sheds a bad light on us. If the site in question is making fair use of the material, linking is OK.

3.15 If you find a copyright infringement

It is not the job of rank-and-file Wikipedians to police content for possible copyright infringement, but if you suspect one, you should at the very least bring up the issue on that page's talk page. Others can then examine the situation and take action if needed. The most helpful piece of information you can provide is a URL or other reference to what you believe may be the source of the text.

Some cases will be false alarms. For example, if the contributor was in fact the author of the text that is published elsewhere under different terms, that does not affect their right to post it here under the GFDL. Also, sometimes you will find text elsewhere on the Web that was copied from Wikipedia. In both of these cases, it is a good idea to make a note in the talk page to discourage such false alarms in the future.

If some of the content of a page really is an infringement, then the infringing content should be removed, and a note to that effect should be made on the talk page, along with the original source. If the author's permission is obtained later, the text can be restored.

If *all* of the content of a page is a suspected copyright infringement, then the page should be listed on [Wikipedia:Copyright problems](#) and the content of the page replaced by the standard notice which you can find there. If, after a week, the page still appears to be a copyright infringement, then it may be deleted following the procedures on the votes page.

In extreme cases of contributors continuing to post copyrighted material after appropriate warnings, such users may be blocked from editing to protect the project.

If you are the owner of Wikipedia-hosted content being used without your permission

If you are the owner of content that is being used on Wikipedia without your permission, then you may request the page be immediately removed from Wikipedia; see [Request for immediate removal of copyright violation](#). You can also contact our [Designated agent](#) to have it permanently removed, but it may take up to a week for the page to be deleted that way (you may also blank the page but the text will still be in the page history). Either way, we will, of course, need some evidence to support your claim of ownership.

See also

[Wikipedia:Copyright FAQ](#)

The [Wikipedia:Contributing FAQ](#) for questions on copyright.

Wikipedia's [designated agent](#) under [OCILLA](#)

[Wikipedia:Sites that use Wikipedia as a source](#)

[Wikipedia:Standard GFDL violation letter](#)

[Wikipedia:Possible copyright infringements](#)

[Wikipedia:Spotting possible copyright violations](#)

[Wikipedia:Fair use](#)

[Wikipedia:Image copyright tags](#)

Further discussion...

[Wikipedia:Copyright issues](#)

[m:Wikipedia and copyright issues](#)

[m:Avoid Copyright Paranoia](#)

[m:Permission grant extent](#)

Retrieved

from

["http://en.wikipedia.org/wiki/Wikipedia:Copyrights"](http://en.wikipedia.org/wiki/Wikipedia:Copyrights)

<http://en.wikipedia.org/wiki/Wikipedia:Copyrights>

References

1. Wikipedia Foundation, Inc., Wikimedia. <http://en.wikipedia.org/wiki/Wikipedia>. 2006.
2. Wikimedia Foundation, Inc. Copyrights. <http://en.wikipedia.org/wiki/Wikipedia:Copyrights>. 2006.