

## Effect of Ionized Plasma Medium on Radiation Properties of Rectangular Microstrip Antenna Printed on Ferrite Substrate

Ayman Al sawalha

Department of Physics, Faculty of Science, Jerash University, P.O. Box 311, Jerash, JORDAN

**ABSTRACT:** This paper presents theoretical investigations on the radiation of rectangular microstrip antenna printed on a magnetized ferrite substrate  $Ni_{0.62}Co_{0.02}Fe_{1.948}O_4$  in the presence of ionized plasma medium. The theoretical study on rectangular microstrip antenna in free space is carried out by applying the transmission line model combining with potential function techniques while hydrodynamic theory is used for its analysis in plasma medium. By taking the biased and unbiased ferrite cases, far field radiation patterns in free space and plasma medium are obtained which in turn are applied in computing radiated power, directivity, quality factor and bandwidth of antenna. It is found that the presence of plasma medium affects the performance of rectangular microstrip antenna structure significantly.

[Ayman Al sawalha. **Effect of Ionized Plasma Medium on Radiation Properties of Rectangular Microstrip Antenna Printed on Ferrite Substrate.** *N Y Sci J* 2014;7(11):52-57]. (ISSN: 1554-0200). <http://www.sciencepub.net/newyork>. 7

**Key words:** Microstrip Antenna, Ferrite, Plasma

### 1 - Introduction

Demand for compact radiators with sufficiently high gain is rapidly increasing in many application areas, as modern wireless telecommunication systems and space communications require compact antennas with high gain, which become even more relevant requirements when the radiating elements have to be combined in large antenna arrays for satellites, space vehicles, airplanes, and so on.

Microstrip patch antennas, due to their inherent capabilities (mainly low cost, low weight and low profile) are widely used in those setups [1], [2]. Even though such antennas are very thin compared to the operating wavelength (0.05-0.01  $\lambda$ ) in their cross section, however, still their transverse dimensions cannot be made arbitrarily short, since a regular patch antenna resonates at a given frequency when its linear transverse dimension is of the order of half wavelength.

An antenna mounted on a space vehicle interacts with high-density warm and non-drifting ionized plasma medium during its re-entry into the Earth's atmosphere. This high density plasma medium affects the radiation performance of the antenna significantly. In the present paper, effect of this plasma medium on the radiation properties of rectangular microstrip antenna designed on a typical ferrite substrate  $Ni_{0.62}Co_{0.02}Fe_{1.948}O_4$  in the case of biased ferrite and unbiased ferrite where in the case of biased ferrite the DC magnetic biased field is taken normal to the direction of propagation of electromagnetic waves, are investigated theoretically. Transmission line model combining with potential function techniques is used

to obtain radiation properties of rectangular microstrip antenna in free space while hydrodynamic theory is used to obtain its radiation properties in plasma medium. It has been established that, for a biased ferrite slab, a normal incident plane wave may excite two type of waves (i.e. the ordinary and extraordinary wave). In the case of a normal incident wave, the ordinary wave is the same as the plane wave in a dielectric slab transversely to the biasing direction. On the other hand, the extraordinary wave is a TE mode polarized parallel to the biasing direction with its phase propagation constant  $K_e$ . The phase propagation constants  $K_e$  and  $K_o$  of an extraordinary and an ordinary wave, respectively, may be given as follows [2,3].

$$K_e = \frac{2\pi f}{c} \sqrt{\epsilon_{\text{reff}} \mu_{\text{reff}}} \quad (1)$$

$$K_o = \frac{2\pi f}{c} \sqrt{\epsilon_{\text{reff}}} \quad (2)$$

$$\mu_{\text{reff}} = \frac{\mu_r^2 - \kappa_r^2}{\mu_r} \quad (3)$$

$$\mu_r = \mu_o \left[ 1 + \frac{\omega_o \omega_m}{\omega_o^2 - \omega^2} \right] \quad (4)$$

$$\kappa_r = \mu_o \left[ \frac{\omega \omega_m}{\omega_o^2 - \omega^2} \right] \quad (5)$$

$$\omega_o = \gamma(\mu_o H_o) \tag{6}$$

$$\omega_m = \gamma(\mu_o M_s) \tag{7}$$

Where  $H_o$  is the biased field,  $4\pi M_s$  is the saturation magnetisation,  $\gamma$  is the gyromagnetic ratio as  $\gamma = 2.8\text{MHz/Oe}$ .

In the case of extraordinary mode, the propagation constant dependence on basic parameters is give as:

$$\left(\frac{K_e}{K_o}\right)^2 = \frac{(\omega_o + \omega_m)^2 - \omega^2}{\omega_o(\omega_o + \omega_m) - \omega^2} \tag{8}$$

It is seen that, when  $\mu_{eff}$  is negative, the extraordinary wave is decaying even if the material is lossless. The frequency range for negative  $\mu_{eff}$  is

$$[\omega_o(\omega_o + \omega_m)]^{\frac{1}{2}} < \omega < (\omega_o + \omega_m) \tag{9}$$

The frequency limit define the approximation range within and around which the ferrites exhibit interesting microwave characteristics .The use of a biased field to control the properties of the extraordinary wave results in an externally switchable antenna .The antenna is 'of ' when an attenuating extraordinary wave in the ferrite propagates and there is a little radiation and is 'on' when  $\mu_{eff}$  is positive and the ordinary wave is propagating.

**2 - Theoretical Considerations**

The geometry and coordinate system of rectangular microstrip antenna are shown in Fig.1, the thickness of substrate is  $h$ , width is  $W$  and the length is  $L$ .

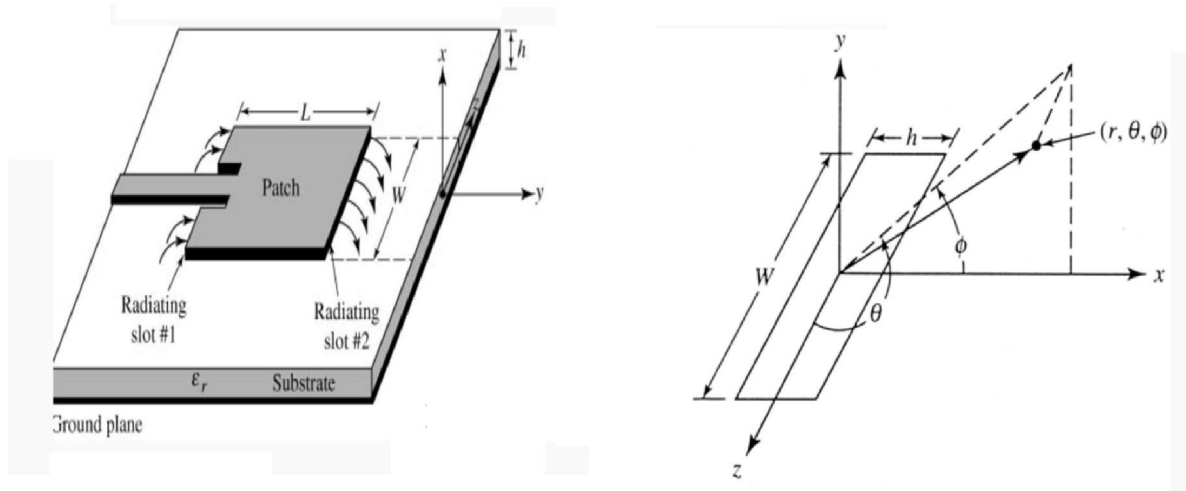

Fig. (1): The geometry and coordinate system of rectangular microstrip antenna

The total field in isotropic warm plasma can be decomposed in two modes, namely, transverse electromagnetic mode (EM mode) and longitudinal electroacoustic mode (plasma mode). Physically the separation of fields into two modes means that the electromagnetic and plasma wave excited by the radiating source are uncoupled .It is pertinent to mention here that electrons are assumed to be the only effective component of plasma to respond to the time varying fields. The collisions of the electrons with neutral particles, the effect of sheath formation around the antenna and the presence of external magnetic field are disregarded. For the validity of these assumptions, linearized hydrodynamic theory of plasma have been used [4].Following it ,the far-zone field expressions for a rectangular microstrip patch antenna are obtained as [5]

**a - In electromagnetic mode:**

$$\therefore E_\phi = \frac{-j\beta_o A E_o h W}{\pi r} \sin \theta \cos(\beta_e \frac{L}{2} \sin \theta \sin \phi) \left[ \frac{\sin x}{x} \cdot \frac{\sin z}{z} \right] e^{-j\beta_e r} \tag{10}$$

$$x = \beta_e (h/2) \sin \theta \cos \phi$$

$$z = \beta_e (W /2) \cos \theta$$

$$\beta_e = \beta_o A = \frac{2\pi}{\lambda_o} A$$

$$A = (1 - \omega_p^2 / \omega^2)^{1/2}$$

$$E_\theta = 0$$

**b - In Plasma mode**

$$E_p = \frac{60(1 - A^2)}{A^2} \frac{E_o \beta_p c}{r \omega} \cos(\beta_p \frac{L}{2} \sin \theta \sin \phi) [X'] e^{-j\beta_p r} \tag{11}$$

$$[X'] = hW \frac{\sin(\beta_p (h/2) \sin \theta \cos \phi)}{\beta_p (h/2) \sin \theta \cos \phi} \cdot \frac{\sin(\beta_p (W/2) \cos \theta)}{\beta_p (W/2) \cos \theta}$$

where

$$\beta_p = \left( \frac{c}{v_o} \right) \beta_o A$$

In the above expression  $\beta_e$  and  $\beta_p$  are the propagation constant in electromagnetic mode and in plasma mode respectively.

The values of  $|E_\phi|$  and  $|E_p|$  are computed numerically and plotted in Fig.2,3by taking  $f_o = 1GHz$ ,  $h = 0.15cm$ ,  $W =$ ,  $L =$  and  $\epsilon_r = 15$

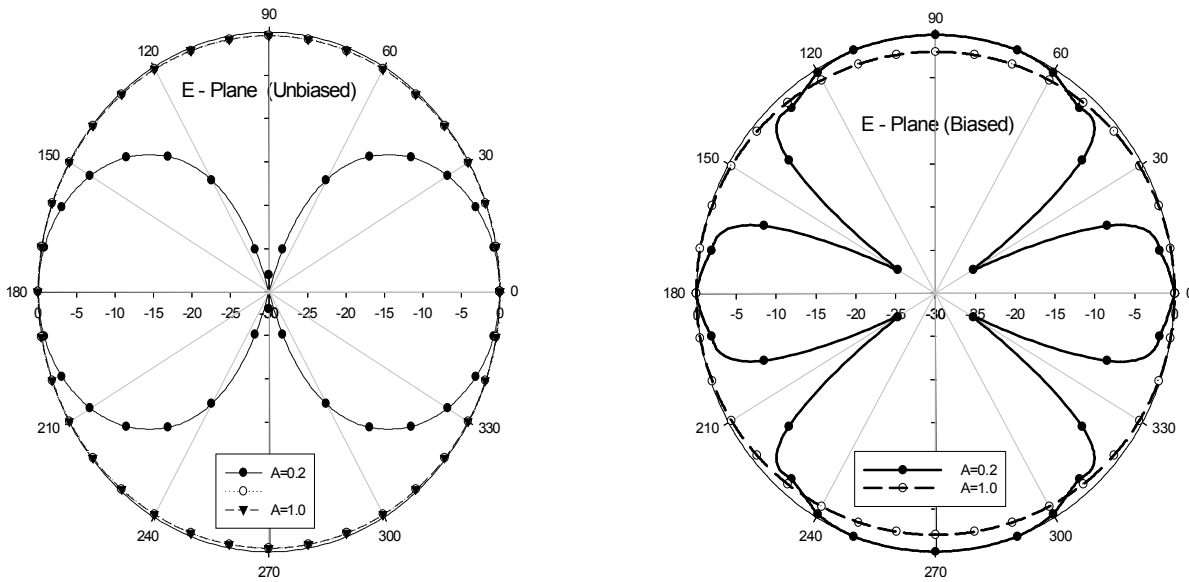

Fig.2:  $|E_\phi|$  for unbiased and biased ferrite for two different values of A.

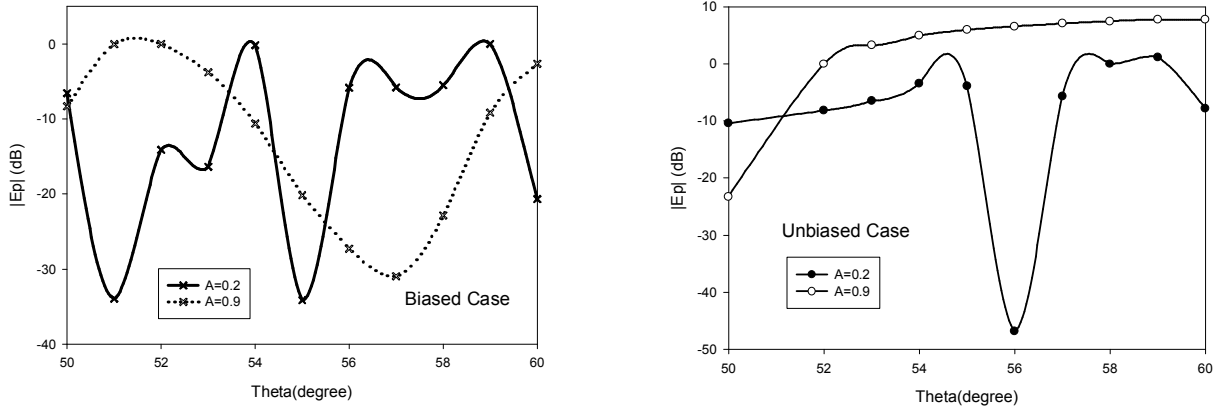

Fig.3:  $|E_p|$  for unbiased and biased ferrite for two different values of A.

**3 - Radiation Conductance**

By integrating the Poynting vector over a large sphere, the expression for radiation conductance of the rectangular patch antenna in electromagnetic mode and plasma mode are give as:

**a - In electromagnetic mode:**

$$G_e = \frac{2P_e}{V^2}$$

Where  $P_e$  the radiated power by the antenna is in electromagnetic mode,  $V$  is the edge voltage and given as  $V = hE_0$  and  $G_e$  is the radiation conductance and is given by:

$$G_e = \frac{A^3 W^2 \beta_o^2}{\pi^2 Z_o} \int_0^{2\pi} \int_0^\pi \left[ \sin^3 \theta \cos^2 \left( \beta_e \frac{L}{2} \sin \theta \sin \phi \right) \frac{\sin^2 x}{x^2} \frac{\sin^2 z}{z^2} \right] d\theta d\phi \quad (12)$$

The value of  $P_e$  is calculated for different values of plasma to source frequencies in case of biased and unbiased ferrite and plotted in figure (4).

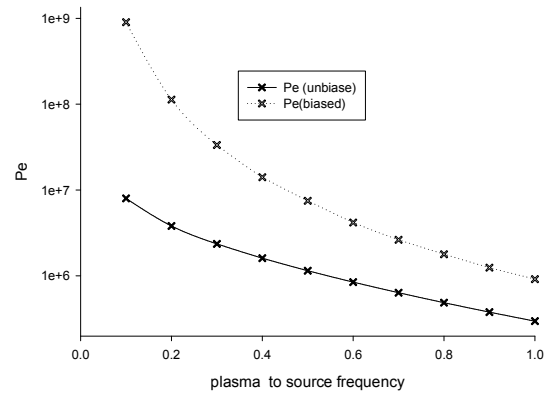

Fig.4:  $P_e$  for different  $(\omega_p/\omega)$  in case of biased and unbiased ferrite

**b - In plasma mode:**

$$G_p = \frac{2P_p}{V^2}$$

Where  $P_p$  the radiated power by the antenna in plasma mode is,  $G_p$  is the radiation conductance and is given by:

$$G_p = \frac{(1-A^2)^2 (60)^2 W^2 \beta_o^2 c}{A^3 \omega^2 Z_o} \int_0^{2\pi} \int_0^\pi \left[ \cos \left( \beta_p \frac{L}{2} \sin \theta \sin \phi \right) \frac{\sin X'}{X'} \frac{\sin Z'}{Z'} \right]^2 \sin \theta d\theta d\phi \quad (13)$$

The value of  $P_p$  is calculated for different values of plasma to source frequencies in case of biased and unbiased ferrite and plotted in figure (5).

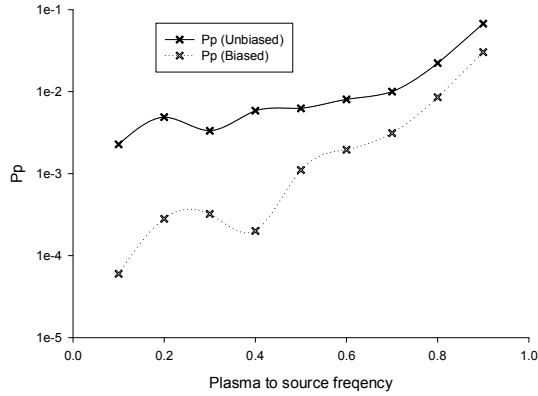

Fig.5:  $P_p$  for different  $(\omega_p/\omega)$  in case of biased and unbiased ferrite.

**4 - Directive Gain**

The directive gain of an antenna in a given direction is defined as the ratio of the maximum radiation intensity  $F_{max}(\theta, \phi)$  in that direction to the average radiated power in electromagnetic mode and given by:

$$D_e = 4\pi \frac{F_{max}(\theta, \phi)}{P_e} \tag{14}$$

$$F_{max}(\theta, \phi) = \left[ |E_\theta(\theta, \phi)|^2 + |E_\phi(\theta, \phi)|^2 \right]_{max}$$

The value of directivity is calculated for different values of  $A = \sqrt{1 - (\omega_p/\omega)^2}$  in case of biased and unbiased ferrite and plotted in figure (6).

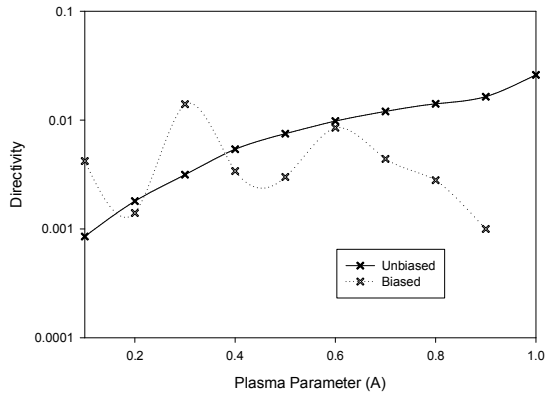

Fig. 6:  $D_e$  for different values of  $A$  in case of biased and unbiased ferrite.

**5 – Efficiency**

Efficiency  $\eta$  of an antenna can be calculated as [6]:

$$\eta = \frac{P_e}{P_e + P_p} \times 100\% \tag{16}$$

From equations (12) and (13) the efficiency of an antenna can be calculated. The value of  $\eta$  is calculated and plotted for different values of  $A = \sqrt{1 - (\omega_p/\omega)^2}$  in case of biased and unbiased ferrite as shown in figure (7).

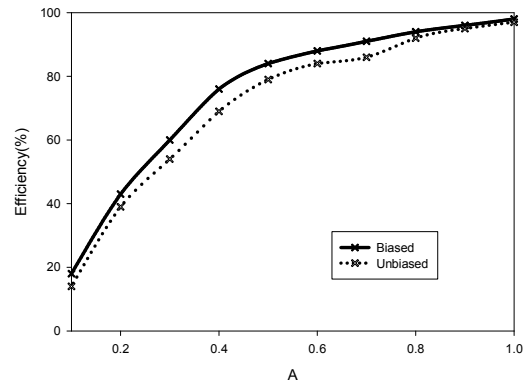

Fig.7:  $\eta$  for different values of

$$A = \sqrt{1 - (\omega_p/\omega)^2} \text{ in case of biased and unbiased ferrite.} \tag{15}$$

**6 – Bandwidth**

The bandwidth (BW) of an antenna is calculated as [5]:

$$BW = \omega_2 - \omega_1 = \frac{\omega_r}{Q_{rad.}} \tag{17}$$

Where  $Q_{rad.}$  is the total quality radiation factor and is given as:

$$Q_{rad.} = \frac{\omega U_T}{P_{rad.}} \tag{18}$$

$U_T$ , is the total stored energy given by:

$$U_T = \frac{\epsilon_o \epsilon_{eff.}}{4} \int_V |E_{max.}|^2 dV \tag{19}$$

The value of  $Q_{rad.}$  is calculated by using the equations (18) and (19) for different values of

$A = \sqrt{1 - (\omega_p / \omega)^2}$  in case of biased and unbiased ferrite as shown in figure (8).

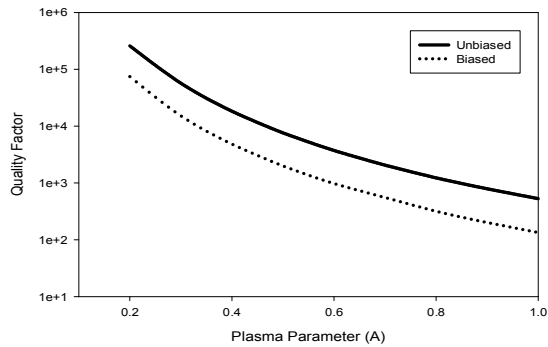

Fig.8:  $Q_{rad}$  for different values of

$A = \sqrt{1 - (\omega_p / \omega)^2}$  in case of biased and unbiased ferrite.

Bandwidth of an antenna is calculated from equation (18) and plotted in figure (9) as shown:

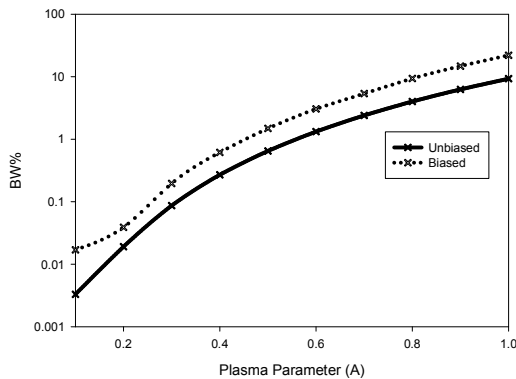

Fig.9: BW for different values of

$A = \sqrt{1 - (\omega_p / \omega)^2}$  in case of biased and unbiased ferrite

### 6 - Discussion and conclusion

In this paper we have developed a concept of switchable antenna and it has been analysed at 1GHz of microwave frequency range by taking rectangular patch microstrip antenna geometry. The parameters used for the study on biased ferrite

substrate are  $4\pi M_s = 3000G$  and biased field  $H_0 = 1000Oe$  while, for unbiased ferrite  $4\pi M_s = 0G$ ,  $H_0 = 0Oe$ .

It is evident from the equation (9) that, there is a frequency range bounded by limits, namely cut-off limit and resonance limit. In this region where  $\mu_{eff}$  is negative, the extraordinary wave is highly attenuating and therefore the antenna is effectively off as radiator.

Some salient features of rectangular geometry are summarized as follows:

- 1- On biasing ferrite the radiation pattern become directive in nature and the number of lobes are found to be greater than that of the unbiased case for  $A = 0.2$  i.e. in plasma medium.
- 2- The size of the patch is considerably reduced when designed on ferrite substrate. This reduction would certainly have a wide use in creating miniaturisation of an antenna system, which has a potential application in space and cellular communication.

### References

- [1] C.A. Balanis, "Antenna Theory: Analysis and Design," 2nd ed., John Wiley & Sons, New York, 1997.
- [2] – Bachyansk M.P., "Plasma physics An Elementry Review", Proc. IRE, vol.49, 1961.
- [3] – Freeston I.L., "Measurments of ion density in a plasma torch using aplane probe", Electron Lett., vol.6, No.25, 1970.
- [4] – Wait J.R., "Radiation from sources immersed in compressible plasma media", Can. J. Physics, vol.42, 1964.
- [5] – Post, R.E., and D.T. Stephenson, "The design of microstrip antenna array for a UHF space telemetry link", IEEE trans., Vol. AP-29,pp.129-133,1981.
- [6]- Mavridis, A.A.,G.A. Kyriacou, and J.N. Sahalos, "On the design of patch antennas tuned by transversely magnetized lossy ferrite including a novel resonating mode," Progress in Electromagnetic Research, PIER 62,165-192, 2006.