

**Varied Plasma Level  
have impact on “GENETIC VALUE”?...**  
(A new theory on “*Species matter*”)

M.Arulmani, B.E.. V.R.Hema Latha, M.A., M.Sc., M.Phil.

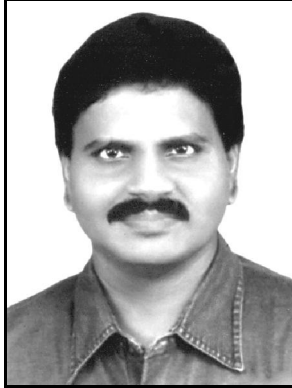

*M.Arulmani, B.E.*  
(Engineer)  
[m.arulmani58@gmail.com](mailto:m.arulmani58@gmail.com)



*V.R.Hema Latha, M.A., M.Sc., M.Phil.*  
(Biologist)  
[vrhemalatha58@gmail.com](mailto:vrhemalatha58@gmail.com)

**1. Abstract:**

This scientific research focus that the whole “**Material Universe**” (Region-III) (Integral part of cosmo universe) shall be considered as “**multi tier**” “**TRIPOD**” like house structure and the multi tier formation shall be considered constructed in three phases of “**Nuclear age**” accommodating the **genetic value** of three generations of matters.

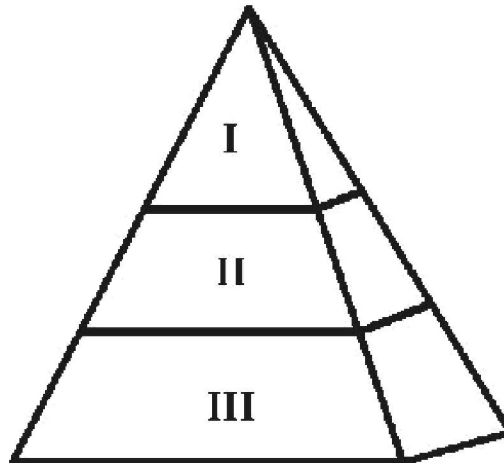

**(Model 3-Tier Cosmo)**

It is further focused that the so called “**modern universe**” shall be considered as contain “**six tier**” regions (zones) above the surface of **SUN, EARTH, MOON**. The sun, earth, moon shall be considered as existing in the same “**base line**” called as “**foundation**” of the cosmo universe.

- i) **J-Radiation Origin**
- ii) **Endo matters zone**
- iii) **Plasma matter zone**
- iv)  **$\gamma$  - matter zone**
- v)  **$\beta$  - matter zone**

**vi)  $\alpha$  - matter zone**

This research further focus that in the ‘**early universe**’ there was no existence of  $\gamma$ ,  $\beta$ ,  $\alpha$  matters and contains only ‘**ENDO MATTERS**’ and ‘**PLASMA MATTERS**’. The plasma matters shall be considered as ‘**IMMUNE ZONE**’ (Sterile Barrier) exists between ENDO MATTERS and the base of cosmo universe.

During the course of ‘**Expanding Universe**’ the ‘endo matters’ shall be considered as descended to ‘**EARTH PLANET**’ transformed through **PLASMA ZONE**. The existence of ‘**EARTH MATTERS**’ shall also be called as ‘**INDO MATTERS**’. Indo matters shall mean genetically opposite in structural, functional characteristics to ENDO matters. In brief ENDO shall mean ‘**REAL**’, INDO shall mean ‘**IMAGE**’ ENDO shall mean **LOGIC**, INDO shall mean ‘**LANGUAGE**’.

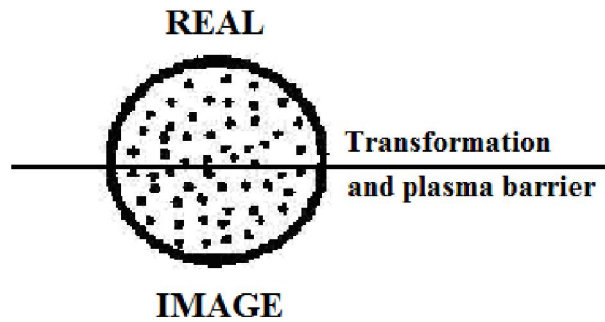

Further it is focused that during the course of expanding universe the ‘**PLASMA ZONE LEVEL**’ of earlier universe shall be considered consistently reduced which result in formation of ‘**Plasma matter**’ and three families of ‘**species matter**’.

- i)  $\gamma$  - family matters
- ii)  $\beta$  - family matters
- iii)  $\alpha$  - family matters

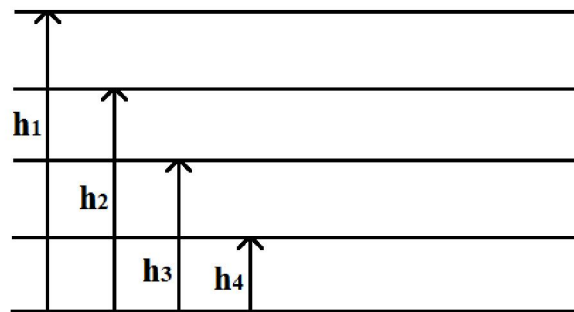

**(Model Plasma Level Variation)**

It is focused that  $\gamma$ ,  $\beta$ ,  $\alpha$  shall be considered as the three distinguished families of ‘**INDO Matters**’. In other words  $\gamma$ ,  $\beta$ ,  $\alpha$  matters shall be considered as ‘**three species matters**’ to ENDO matters belong to ‘**J-FAMILY**’ having distinguished ‘**genetic value**’. The so called ‘**electromagnetic spectrum**’ (UV, RF, IR) shall be considered as group of ‘**Species radiant matters**’ belong to three distinguished family evolved from ‘**White plasma Lightning**’ in three generations

- i) ‘**UV spectrum radiations ( $\gamma$  family)** – Ist generation evolved matter
- ii) ‘**RF spectrum radiations ( $\beta$  family)** – 2<sup>nd</sup> generation evolved matters
- iii) ‘**IR spectrum radiations ( $\alpha$  family)** – evolved matters

‘**Plasma matter**’, shall be considered as matter under Transformation stage” and considered as “source” (**GENUS**) of all species matters of the Universe (**Indo matters**)” ... Author

[M.Arulmani, B.E.. V.R.Hema Latha, M.A., M.Sc., M.Phil. **Varied Plasma Level have impact on “GENETIC VALUE”?**.... Rep Opinion 2014;6(5):7-18]. (ISSN: 1553-9873). <http://www.sciencepub.net/report>. 3

**2. Key Words:**

- a) New definition for “Plasma”?...
- b) Philosophy of “Plasma level variation”?...
- c) Philosophy of “Ammune and Immune”?...
- d) Philosophy of “White hole and white matter”?...
- e) Philosophy of “3G galaxies”?...
- f) Philosophy of “Isotopes and Isobars”?...
- g) Philosophy of “White Ocean”?...
- h) Philosophy of “Plasmacity”?...
- i) Philosophy of “Plasmatic field”?...

**3. Introduction:**

“Bio-genesis” focus that Life originated from “Single cell” organism. But “Abiogenesis” disputes that how “single cell” was formed?... It is the strong emphasis of the author that “Biogenesis” shall be considered as the source of “Abiogenesis”. Bio-genesis shall be considered as “Endo matters” of early universe and Abiogenesis shall be considered as the evolved product of Endomatters through ‘Transformation process’ through “Plasma media”. Biogenesis shall mean “MADI”, “GENUS”, “ORIGINAL”. Abiogenesis shall mean “MODI”, “SPECIES”, “COPY”.

The philosophy of “Biogenesis” shall be considered as early universe matters (ENDOS) exist in the upper region of material universe and “Abiogenesis” shall be considered as Modern Universe matters (INDOS) exist in the lower region of material universe. The philosophy of “Fossil remnants” shall be considered as “Plasma Samples” of “Endo matters”.

This research further focus that current theory focuses the **human ancestor** is believed to have originated from Common ancestor of Apes. Apes have hundreds of species. But human is believed as the “**highest evolved product**” and considered have “**No species**”. Nature has any peculiar law for human alone?....

When every living matters and non-living matters such as Hydrogen, Carbon, Nitrogen, Ozone, have species **Why not human?...** as exception.

This scientific research strongly emphasize that all matters including human also have “SPECIES”. Human shall be considered as having distinguished “genus” called as “**ENDO HUMAN**” or “**Human-e**”. The INDO Human or “**Human**” shall be considered as “**EARTH MATTER**” transformed through “**Plasma Zone**” of Universe and started living on “**EARTH PLANET**” during space and time.

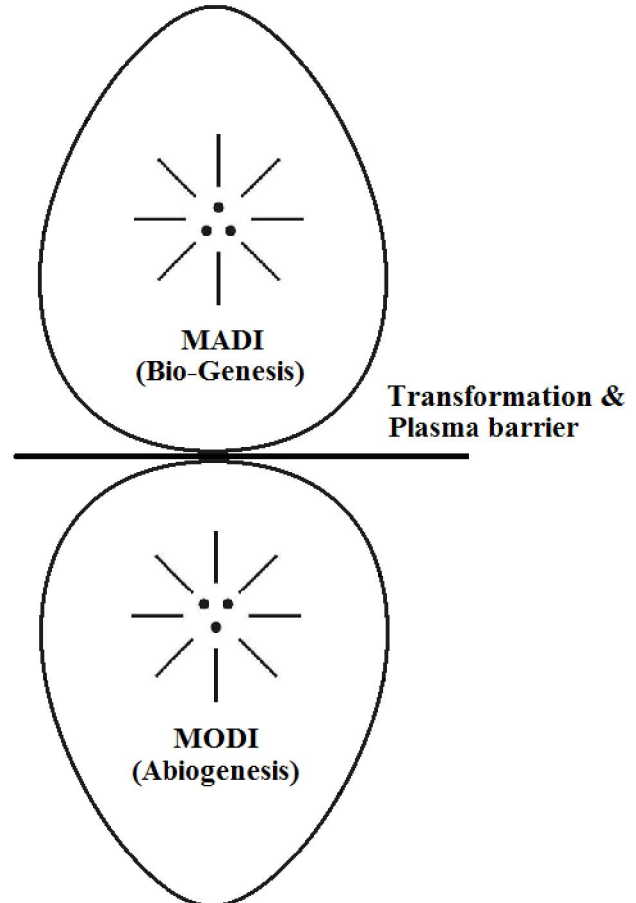

It is focused that the “**INDO HUMAN**” shall be considered as having three genetically varied “**human species**” evolved due to “**Plasma level variation**” of Universe in three “**Nuclear age**”. The three species shall be considered as **3G matters** (Three domain human) under three major human families. Thousands of Human races shall be considered as classified under “three Domain human families”.

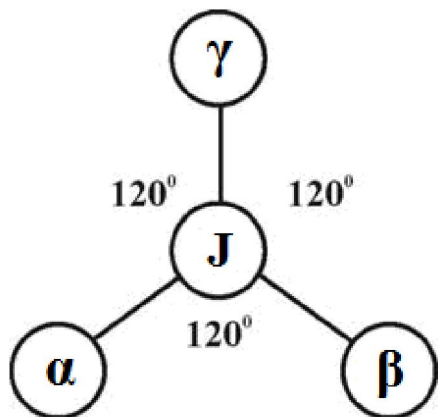

**(Three Domain Family)**

- i) Endo Human – “J-family”
- ii) Plasma Human – Transformation Phase
- iii) INDO human – “Species family”
- iv) Ist Generation human -  $\gamma$  - family
- v) 2<sup>nd</sup> Generation human -  $\beta$  - family
- vi) 3<sup>rd</sup> Generation human -  $\alpha$  - family

Further  $\gamma$ ,  $\beta$ ,  $\alpha$  families of human shall be considered as genetically varied species having distinguished “**Immunity level**” due to distinguished “**varied plasma level**” of “environment” zone where particular “**human races**” were evolved.

- i)  $\gamma$  - species - Higher plasma level zone
- ii)  $\beta$  - species - Medium plasma level zone
- iii)  $\alpha$  - species - Low Plasma level zone

*“The philosophy of white cloud, white lightning, white rainbow, corono discharge, celestial stars, Ionised gas, welding arc, laser beam, human cytoplasm, protoplasm blood plasma, cartilage bone, human breast vaginal passage, human penis shall be considered as different species of fundamental “PLASMA LEVEL MATTER”.*

--- Author

**4. Hypothesis:**

**a) Philosophy of J-Radiation?...**

It is hypothesized that “J-Radiation” shall be considered as the most fundamental radiation of the material universe emanated from “**WHITE HOLE ZONE**”. The white hole region shall be considered as the source of accelerate energy also called as “**White Light**” (or) “**J-Radiation**”. The J-Radiation shall be considered as the region where “**SPIRIT**” becomes “**SOULS**”. the J-Radiation shall also be considered as “**SOUL OF MATTERS**” comprise of most fundamental Neutrino particles Photon, Electron,

Proton having zero mass and having pre defined polarity **Optic, Electric, Magnetic** properties. Further J-Radiation shall be considered composed of “**Billions of rays**” distinguished by minute difference in particle mass and each ray shall be considered as representing “Soul” (**GENUS**) of each “**ENDO MATTERS**”.

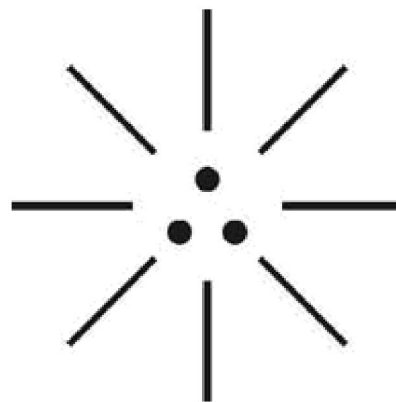

**(ENDO GENUS)**

The concept of genus of some samples of endo matter are narrated below:

(i)

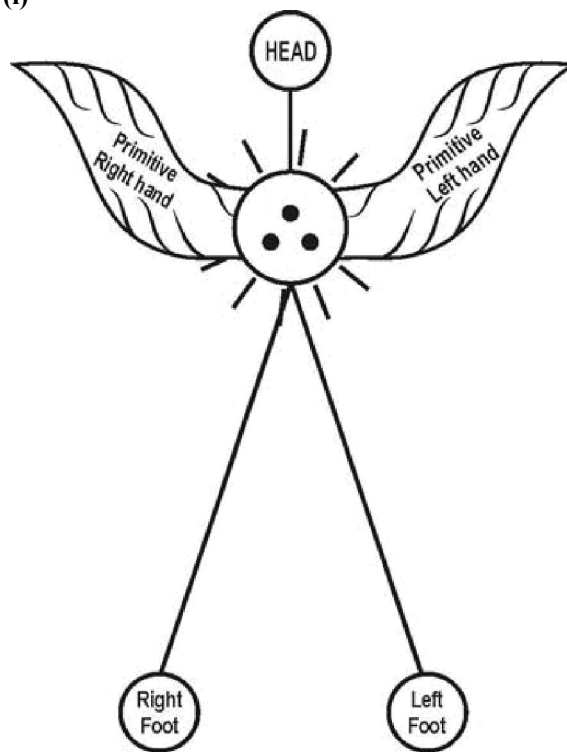

**(ENDO HUMAN)**

(ii)

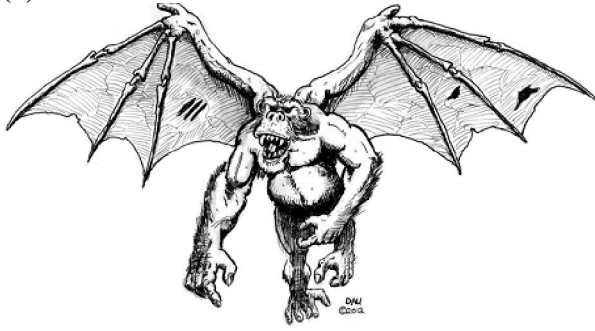
**(ENDO APES)**

It is hypothesized that Billions of all Endo matters shall be considered originated with only **“Three chromosome”** minutely distinguished by particle mass in each genus of matters. This philosophy shall be considered like, existence of **“ATOM”** having **“ISOTOPE ISOBARS”**

It is hypothesized than billions of all Endo matters shall be considered originated with only **“Three chromosome”** minutely distinguished by particle mass in each genus of matters. This philosophy shall be considered like existence of **“Atom”** having **“ISOTOPE” “ISOBARS”**.

It is focused that the whole **“ENDO MATTERS”** shall be considered as created (originated) under fundamental **“three domain”**. Each minute dot within each domain shall be considered as repressing each **“genus”** of matter.

**b) Philosophy of PLASMA MATTER?...**

Case study shows that in Plasma Physics **“Plasma”** is considered as the state of existence of gas in ionized form within then boundary of charged electrodes. In physical chemistry plasma is considered as the **“Fourth state”** of matter beyond the state of solid, liquid, gas. In biology plasma is considered as the yellow wish liquid within which the blood elements platelets, RBC, WBC are suspended and considered as Transformation material to transport Blood elements to various part of cell and Tissues. In astronomic many stars and planets are considered as existing in plasma stage.

It is focused that current plasma theory could not exactly clarify the following.

- a) What exactly plasma means?...
- b) What is the source of plasma?...
- c) Where exactly plasma zone exists in the universe?...
- d) How many species the plasma matter have?...
- e) Plasma matter has any colour?...
- f) What plasma is made up of?...

It is focused that the most fundamental plasma shall be called as **“ALASMA”**. The **“Alasma matter”** shall be alternatively called as **“J-Radiation”**. In the material universe **“White hole zone”** shall be considered as the source of Alasma.

The Alasmo matter shall be considered as composed of fundamental neutrinos **photon, Electron, proton** having **Zero mass**...

It is focused that the **“plasma matter”** shall be consider as having little higher particle mass and considered as species to alasma matter. Further the most fundamental plasma matter shall be considered as white colour and Millions of plasma species of varied mass varied colour shall be considered exist just like **“grains of sand”** and no scientist can count and ascertain the existence of total plasma species in the universe.

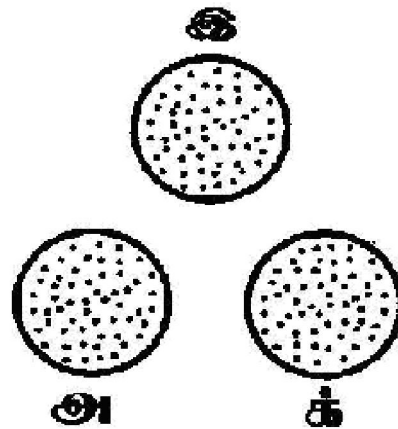
**(3G Plasma Species)****c) Philosophy of plasma level variation?...**

It is hypothesized that the whole material universe shall be considered as fully **“VOID”** without formation of any matters. In the expanding universe the **“white hole”** shall be considered as formed at one stage and Billions of ENDO matters shall be considered exist in the **“upper zone”** (**Says MARS**) of material universe. At this stage the whole universe consider contains only ENDO matters and vast ENDO plasma matter consider exist between ENDO matters and the base of cosmo expanding universe 1<sup>st</sup> stage reduction in plasma level consider produced  $\gamma$ -family radiations (UV) just above the surface of bottom of universe. Similarly 2<sup>nd</sup> 3<sup>rd</sup> stage reduction in plasma level B-family radiation (RF) ~ families radiation (IR) evolved which result in evolution of species matters in the respective zone of universe. It is hypothesized that the present **“Modern Universe”** the space above base of Universe



consider under the influence of IR radiation rather UV radiation in the early universe.

- (i) H1 – Plasma level in **Early Universe**
- (ii) H2 – Plasma level in **Ancient Universe**.
- (iii) H3 – Plasma level in **Modern Universe**
- (iv) H4 – Plasma level in **Post Modern Universe**.

In brief it is stipulated that the base of universe considered under the impact of UV, RF, IR radiations in different nuclear age which resulted in **evolution of three species of matters** to the “fundamental genus”. It is hypothesized that the “three species domain” shall also be called as three distinguished “galaxies” say **Blue galaxy, Green galaxy, Red galaxy**.

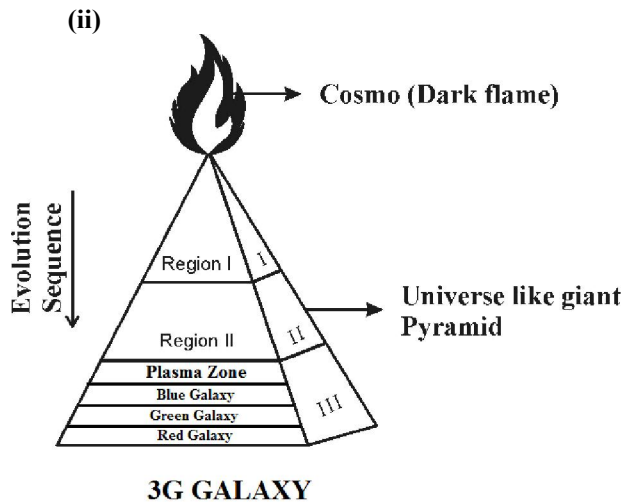
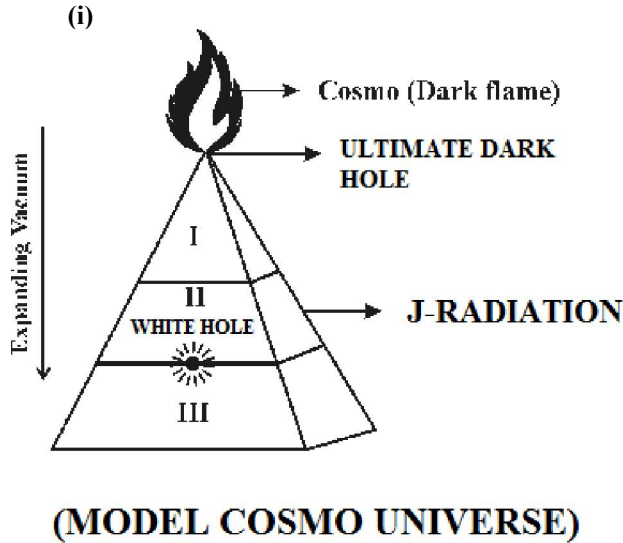

It is further stipulated that in the expanding universe the “**Plasma level Zone**” of Universe consistently gets reduced and the genetic value of modern universe environment gets altered consistently which result in consistent evolution of unexpected “**New species**”. The consistent reduction in “Plasma

Zone level” shall also be termed as “**SICK UNIVERSE**”, (or) “**GLOBAL WARMING UNIVERSE**”.

**d) Philosophy of Human cell?...**

Human cell is considered as basic unit required for structural and functional part of human. It is hypothesized that cell shall be considered a “species plasma matter” of “J-Radiation” composed of fundamental particles photon, electron, proton. It is further hypothesized that the “**ENDO HUMAN**” lived in the upper zone of material universe (say MARS Region) shall be considered as having only “**Three chromosome**” derived each one from Photon, Electron, Proton. Subsequently due to consistent plasma level zone variation genetically varied human might be evolved, with **46 chromosome** in the modern universe.

*“The 46 chromosome human shall be considered as “**INDO HUMAN**” and considered as species to “**ENDO HUMAN**” who have only 3 chromosome”.*

..... Author

**e) Case study on cesarean Birth:**

Nowadays C-Section being commonly practiced just like spitting the chocklet from the mouth”. Case study shows that Babies born by cesarean birth (also called as C-Section) experiences changes to the DNA pool in their white blood cells, which could be connected to altered stress levels during this method of delivery. It is through that these genetic changes which differ from normal vaginal deliveries, could explain why people delivered by C-Section are more susceptible to **immunological diseases** such as diabetes, Asthma, in later life, when those genetic changes combines with “**environmental triggers**”.

..... Source: Science Daily.

**Hypothetical Narration:**

It is emphasized by the author that the “**ENDO HUMAN**” shall be considered as having “**High Immunity**” due to higher plasma zone level in the early universe and could have lived for thousands of years with long life span without any diseases. The “**Indo human**” species shall be considered as consistent loosing immunity due to consistent reduction in plasma zone level and during modern time the life span of human might be drastically reduced to very lower level.

It is further hypothesized that the “**BIRTH CANAL**” shall be considered as the **PLASMA ZONE** comprise of **PLASMA CELLS** which is responsible for Human immunity. It is focused that the delivery of Baby through “**birth canal**” shall be considered as the “**Transformation phase**” where baby gains move immunity from the plasma cells enriched passage. If the baby is directly removed from uterus by passing the birth canal consider loosing the Birth cycle of a baby and loosing the immunity which result in impact on **genetic value and immunity**.

Case study further slows that the C-Section birth was practiced since ancient time and the subsequent genetic changes in human which might be passed on to next generations and could have produced “**genetically varied human species**”.

It is further focused that C-Section birth is adopted normally for Human alone and not on other animals. It is further focused that the philosophy of “**Cloning**” and “**Hybrid variety**” in plants shall be considered as the violating the normal “**Reproduction phase**” and which may have further impact on genetic value on future generations of life matters.

**f) Mother’s womb is like Material Universe?...**

It is hypothesized that “**MOTHER**” shall be considered as the “cosmo universe” and Mother’s Womb, the integral part of mother shall be considered as “**material universe**” (Region III) where all universal matters consider exist.

It is focused that the process of “**Expanding Universe**” shall be considered like “evolutionary process” from the stage of “embryo” to formation of “**full fledged Infant**”.

The philosophy of three “**Trimester**” shall be considered like three nuclear age and the stage of infant in each trimester shall be considered like “Distinguished species” as stipulated below.

- i) Embryo - Upper Universe (Mars region)
- ii) Zygote - **Plasma Transformation**
- iii) 1st Trimester - 1<sup>st</sup> species
- iv) 2<sup>nd</sup> Trimester - 2<sup>nd</sup> species
- v) 3<sup>rd</sup> Trimester - 3<sup>rd</sup> species

**g) Philosophy of Birth?...**

It is hypothesized that the stage of formation of various “**ENDO MATTERS**” in the early universe due to impact of “J-Radiation” in the upper region of Universe.

**h) Philosophy of REBIRTH?...**

It is hypothesized that at one stage the Endo matters exist in the upper region of universe (says mars region) descended to bottom of universe through “**PLASMA REGION**” of Universe and become **INDO MATTERS** and considered become evolved into Three-Indo species.

(i)

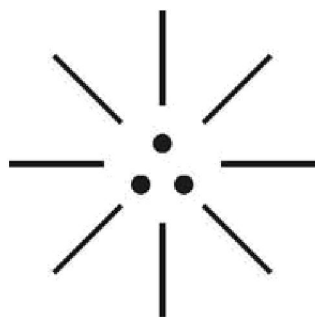

**(EMBRYO)**

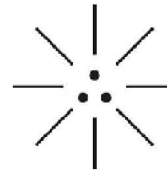

**(INFANT)**

**Transformation & Plasma barrier**

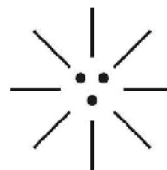

**(HUMAN)**

(ii)

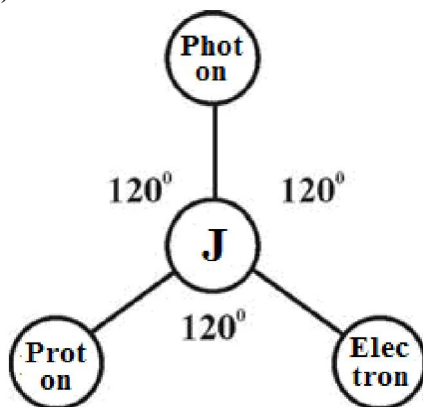

**(HUMAN-e)**

**i) Philosophy of Evolution?...**

It is hypothesized that the “**ENDO MATTERS**” exist in the upper region of Universe shall be considered as “**CREATED PRODUCTS**”. After Transformation through “**Plasma zone**” the growth of “**INDO MATTERS**” become various species such as Isotopes Isobars shall be considered as

(i)

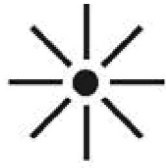

**CHULARCHI**  
**(ENDO)**

(ii)



**PURACHI**  
**(PLASMA)**

(iii)

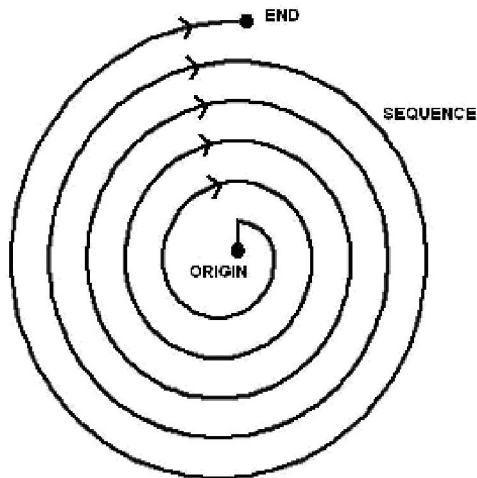

**VALARCHI**  
**(INDO)**

The white plasma cloud consider composed of fundamental ionized particles Photon, electron, Proton and become transformed into Billions of “**INDO MOTHERS**” of Universe.

(i)

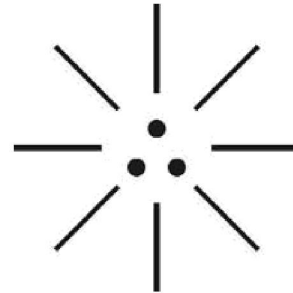

**(White Plasma)**

(ii)



**(PLASMA MOTHER)**

Further in human Parameters the state of white Plasma cloud shall be considered as “**ENRICHED COMMON SENSE**” rather than “**INTELLIGENCE**” shall enriched common sense consider exist in three – in – one – fundamental form.

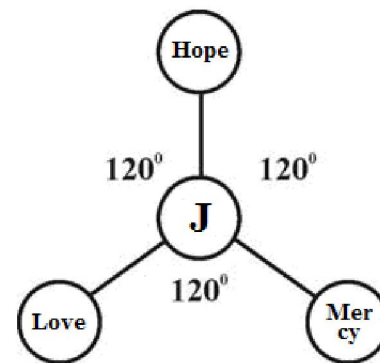

**(COMMON SENSE)**

**j) Philosophy of “PLASMA MOTHER”?...**

In cosmological language the philosophy of “**Virgin Mother**” shall be considered as the stare of “**White Plasma cloud**” and Centromere of material Universe shall be “**PLASMA MOTHER**”.

Further the virgin mother shall be called in various languages as stipulated

(i) Endo language “**Mari-e**”



- (ii) Indo language -  
"Thai-e"
- (iii) Sentamil -  
"Ammoo"
- (iv) Chemozhi tamil -  
"Amma"
- (v) Muthamil -  
"Ammaiyar"

"The "Virgin Mother" shall be considered like a "CREATIVE MECHANISM" of Material Universe rather than delivering the baby through "Plasma birth canal" (or) "C-section" "

- Author

**k) Philosophy of "Plasmacity"?...**

It is focused that Plasmacity shall be considered as referred to property of Plasma mother, having three dimensional "Transmission Characteristics" (ie.) mobility of Photon, Electron, Proton in the space having "Super conductivity" behaviors much beyond the speed of Light . In the early Universe the existences of mother in highly "ionized" behavior called "Plasmacity".

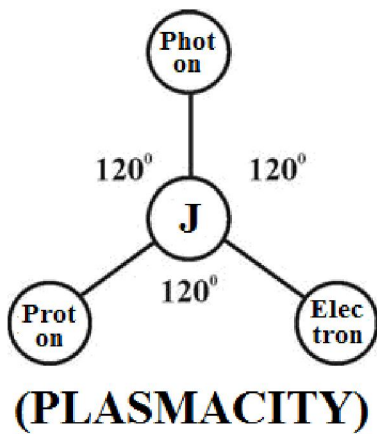

During the course of expanding Universe in three the Nuclear Age the state of mother might be changed to different stare gas, Liquid solid having different "Wave Property" of Transmission like Pulsed ware, Triangular wave, Square ware, sine wave etc. with consistent in reduction in "Transmission speed" below the speed of Light. Restricting to the mobility of only Electrons called as "ELECTRICITY".

Further in Plasma city state of mother "Three fields" property optic, electric, magnetic shall be considered in existence called "Plasmatic field" symmetrically displaced at on angle of 120.

"The philosophy of "Plasmacity of matter" shall be considered as the property of particles capable of Traveling beyond the speed of Light. The plasma city shall be also be called "Neutricity". The term

"Electricity" shall be considered as the property of "Species matters" (Indo matters)"

- Author

**l) Philosophy of ENDO EARTH?...**

It is hypothesized that in the early Universe the Plasma city property of mother shall be considered in existence in "MARS PLANET". The MARS PLANET shall also be called as "ENDO EARTH" (or) "EZHEM". During the course of expanding Universe the Plasma city of matter might be descended from MARS PLANET to EARTH PLANET and become "Species matter" (or) Earth matter exist in the form of Gas, Liquid, solid.

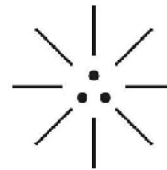

(ENDO EARTH)

**Transformation & Plasma barrier**

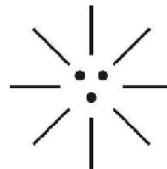

(INDO MARS)

"The "MARS PLANET" shall also be called as "ENDO EARTH". Similarly the "EARTH PLANET" shall also be called as "INDO MARS" "

- Author

**m) Philosophy of PLASMA DEVOLUTION?..**

It is hypothesized that the "Plasmacity State" of matter shall be considered as having "Highest Energy Level". During the course of expanding Universe the Highest Plasma city shall be considered as consistently "Devolved" into lower energy level become three distinguished species to "ENDO GENUS MATTER"

It is further focused that the so-called "Modern Human" shall be considered as "DEVOLVED SPECIES" to "ENDO HUMAN" level. In fact philosophy of "Wisdom" shall be considered as "ENDO", and "Intelligence" shall be considered as "INDO".

Further it is focused that three distinguished intelligence level shall be called as Blue intelligence, Green intelligence, Red intelligence of INDO Matters.

- (i) White intelligence - **ENDO Matter**
- (ii) Blue Intelligence - **INDO 1<sup>st</sup> Species**
- (iii) Green intelligence - **INDO 2nd Species**
- (iv) Red intelligence - **INDO 3rd Species**

**n) Philosophy of Plasma Food?..**

It is hypothesized that “INDO Matters” shall be considered as Species food derived from ENDO matter (or) Plasma food. In Prehistoric Tamil the Plasma food shall be considered as “Ammutham” (Manna) and INDO food shall be considered as “Theevanam” (Honey, Rain, Milk).

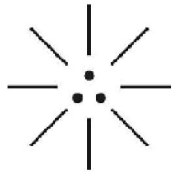

**MANNA (Ammutham)**

**Transformation & Plasma barrier**

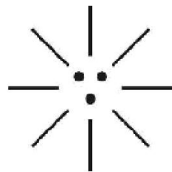

**HONEY, RAIN, MILK (Theevanam)**

**o) Philosophy of Plasma language?...**

In global language research **Robert Caldwell, Veeramamunivar, Paruthimar Kalaingar, Devaneyya pavanar** are considered as Scholars who contributed much about the philosophy of “**Language evolution**” especially the origin of **Dravidian family** of language, Greek, Latin, Sanskrit, Tamil.

It is hypothesized that the language shall be considered as evolved from ‘**Indo matter**’ descended from Endo matter (or) **Plasma matter**. The philosophy of language shall be considered as “**INDO**” and “**LOGIC**” shall be considered as high level scientific language derived from fundamental Particles Photon, Electron, Proton. (ENDO).

(i)

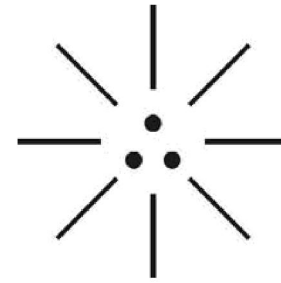

**(e-THAMIL)**

(ii)

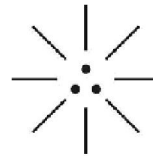

**(LOGIC)**

**Transformation & Plasma barrier**

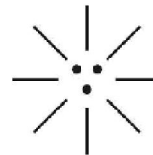

**(LANGUAGE)**

It is further focused that “**e-THAMIL**” shall be considered as Logic rather than language

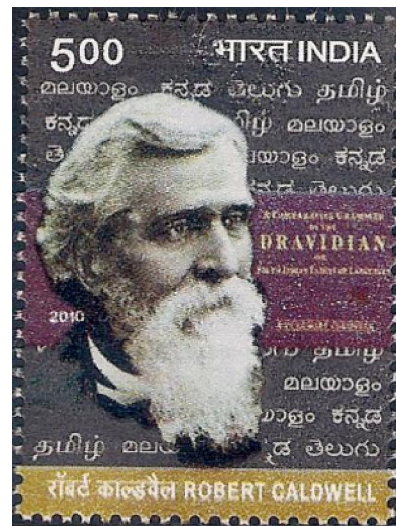

**(BRITISH MGR)**

It is focused the “**Indo-Europe**” great person Robert Caldwell (1814-1891), born on **07<sup>th</sup> May 1814** and dedicated for Indian soil, who contributed more about origin of earliest language in the history shall be called “**TAMIL THIRUVALLUVAR**” (or) “**BRITISH MGR**”

*“For Tinnevely I have lived and for Tinnevely I am prepared to die”*

*- Robert Caldwell*

##### 5. Conclusion:

Human is considered as more valuable among living organisms and having more **genetic value**. **Endo human, Endo apes** shall be considered as distinguished genus of Endo matters.

##### 6. Previous Publication:

The philosophy of origin of first life and human, the philosophy of model Cosmo Universe, the philosophy of fundamental neutrino particles have already been published in various international journals mentioned below. Hence this article shall be considered as **extended version** of the previous articles already published by the same author.

1. Cosmo Super Star – IJSRP, April issue, 2013
2. Super Scientist of Climate control – IJSER, May issue, 2013
3. AKKIE MARS CODE – IJSER, June issue, 2013
4. KARITHIRI (Dark flame) The Centromere of Cosmo Universe – IJIRD, May issue, 2013
5. MA-AYYAN of MARS – IJIRD, June issue, 2013
6. MARS TRIBE – IJSER, June issue, 2013
7. MARS MATHEMATICS – IJERD, June issue, 2013
8. MARS (EZHEM) The mother of All Planets – IJSER, June issue, 2013
9. The Mystery of Crop Circle – IJOART, May issue, 2013
10. Origin of First Language – IJIRD, June issue, 2013
11. MARS TRISOMY HUMAN – IJOART, June issue, 2013
12. MARS ANGEL – IJSTR, June issue, 2013
13. Three principles of Akkie Management (AJIBM, August issue, 2013)
14. Prehistoric Triphthong Alphabet (IJIRD, July issue, 2013)
15. Prehistoric Akkie Music (IJST, July issue, 2013)
16. Barack Obama is Tamil Based Indian? (IJSER, August issue, 2013)
17. Philosophy of MARS Radiation (IJSER, August 2013)
18. Etymology of word “**J**” (IJSER, September 2013)
19. NOAH is Dravidian? (IJOART, August 2013)
20. Philosophy of Dark Cell (Soul)? (IJSER, September 2013)
21. Darwin Sir is Wrong?! (IJSER, October issue, 2013)
22. Prehistoric Pyramids are RF Antenna?!... (IJSER, October issue, 2013)
23. HUMAN IS A ROAM FREE CELL PHONE?!... (IJIRD, September issue, 2013)
24. NEUTRINOS EXIST IN EARTH ATMOSPHERE?!... (IJERD, October issue, 2013)
25. EARLY UNIVERSE WAS HIGHLY FROZEN?!... (IJOART, October issue, 2013)
26. UNIVERSE IS LIKE SPACE SHIP?!... (AJER, October issue, 2013)
27. ANCIENT EGYPT IS DRAVIDA NAD?!... (IJSER, November issue, 2013)
28. ROSETTA STONE IS PREHISTORIC “THAMEE STONE” ?!... (IJSER, November issue, 2013)
29. The Supernatural “CNO” HUMAN?... (IJOART, December issue, 2013)
30. 3G HUMAN ANCESTOR?... (AJER, December issue, 2013)
31. 3G Evolution?... (IJIRD, December issue, 2013)
32. God Created Human?... (IJERD, December issue, 2013)
33. Prehistoric “J” – Element?... (IJSER, January issue, 2014)
34. 3G Mobile phone Induces Cancer?... (IJERD, December issue, 2013)
35. “J” Shall Mean “JOULE”?... (IRJES, December issue, 2013)
36. “J”- HOUSE IS A HEAVEN?... (IJIRD, January issue, 2014)
37. The Supersonic JET FLIGHT-2014?... (IJSER, January issue, 2014)
38. “J”-RADIATION IS MOTHER OF HYDROGEN?... (AJER, January issue, 2014)
39. PEACE BEGINS WITH “J”?... (IJERD, January issue, 2014)
40. THE VIRGIN LIGHT?... (IJCRAR, January issue 2014)
41. THE VEILED MOTHER?... (IJERD, January issue 2014)
42. GOD HAS NO LUNGS?... (IJERD, February issue 2014)
43. Matters are made of Light or Atom?!... (IJERD, February issue 2014)
44. THE NUCLEAR “MUKKULAM”?... (IJSER, February issue 2014)
45. WHITE REVOLUTION 2014-15?... (IJERD, February issue 2014)
46. STAR TWINKLES!?!... (IJERD, March issue 2014)

47. "E-LANKA" THE TAMIL CONTINENT?... (IJERD, March issue 2014)
48. HELLO NAMESTE?... (IJSER, March issue 2014)
49. MOTHERHOOD MEANS DELIVERING CHILD?... (AJER, March issue 2014)
50. E-ACHI, IAS?... (AJER, March issue 2014)
51. THE ALTERNATIVE MEDICINE?... (AJER, April issue 2014)
52. GANJA IS ILLEGAL PLANT?... (IJERD, April issue 2014)
53. THE ENDOS?... (IJERD, April issue 2014)
54. THE "TRI-TRONIC" UNIVERSE?... (AJER, May issue 2014)
8. "English Dictionary", Oxford Publications
9. Sho. Devaneyapavanar, "Tamil first mother language", Chennai, 2009
10. Tamilannal, "Tholkoppiar", Chennai, 2007
11. "Tamil to English Dictionary", Suravin Publication, 2009
12. "Text Material for E5 to E6 upgradaton", BSNL Publication, 2012
- A. Nakkiran, "Dravidian mother", Chennai, 2007
13. Dr. M. Karunanidhi, "Thirukkural Translation", 2010
14. "Manorama Tell me why periodicals", M.M. Publication Ltd., Kottayam, 2009
15. V.R. Hemalatha, "A Global level peace tourism to Veilankanni", Annai Publications, Cholapuram, 2007

### Reference

1. Intensive Internet "e-book" study through, Google search and wikipedia
2. M.Arulmani, "3G Akkana Man", Annai Publications, Cholapuram, 2011
3. M. Arulmani; V.R. Hemalatha, "Tamil the Law of Universe", Annai Publications, Cholapuram, 2012
4. Harold Koontz, Heinz Weihriah, "Essentials of management", Tata McGraw-Hill publications, 2005
5. M. Arulmani; V.R. Hemalatha, "First Music and First Music Alphabet", Annai Publications, Cholapuram, 2012
6. King James Version, "Holy Bible"
7. S.A. Perumal, "Human Evolution History"
16. Prof. Ganapathi Pillai, "Sri Lankan Tamil History", 2004
17. Dr. K.K. Pillai, "South Indian History", 2006
18. M. Varadharajan, "Language History", Chennai, 2009
19. Fr. Y.S. Yagoo, "Western Sun", 2008
20. Gopal Chettiar, "Adi Dravidian Origin History", 2004
21. M. Arulmani; V.R. Hemalatha, "Ezhem Nadu My Dream" - (2 Parts), Annai Publications, Cholapuram, 2010
22. M. Arulmani; V.R. Hemalatha, "The Super Scientist of Climate Control", Annai Publications, Cholapuram, 2013, pp 1-3

5/6/2014