

GOD HAS NO LUNGS?...*(A new theory on single chamber Heart Human)*

*M.Arulmani, B.E.
(Engineer)*

m.arulmani58@gmail.com

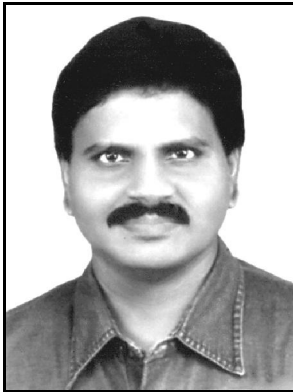

*V.R.Hema Latha, M.A., M.Sc., M.Phil.
(Biologist)*

vrhemalatha58@gmail.com

Abstract: In this scientific research article it is focused that the word “**GOD**” has distinguished meaning from the word “**HUMAN**”. God shall mean the “**Creator**” of human and the living world and universe. Human shall be considered as both created and evolved element. This research focused than the Human on origin, 1st Generation, have only “**SINGLE CHAMBER HEART**” and have **NO LUNGS** as the creator have no lungs. During the Space & Time in the **expanding universe** the single chamber heart of human gradually become “**Four chamber heart**” which necessitated the need of “**LUNGS**” in the human system for **sustainability at Life**. “**Can human live without lungs!... without breathe!!... Vatican news focus that newly elected POPE FRANCIS had only half lung (single unit) and living healthy life for more than 40 years. It is focused that GOD is more than Pope and could survive without lungs.**”-(Author). It is emphasized that the entire universe, matter and life shall be considered as “**Created**” by GOD through “**J-RADIATION**” emitted from the “Single chamber Heart” of GOD. The “**J-RADIATION**” shall also be called as “**SPIRIT**” in scientific term. Billions of rays emitted from the source of “**Spirit**” shall be called as “**SOULS**”. In other words it can be stipulated that Billions of SOULS have been considered created from the **Spirit of GOD**. Human shall be considered as one of the “**Souls**”. It is further focused that each soul shall be considered composed of “**Three-in-one**” fundamental Neutrino particles “**PHOTON**”, “**ELECTION**”, “**PROTON**” differentiated by **minute mass variation** in the “**Spectrum of souls**” having distinguished **Genetic structure and characteristics**. The point of origin of each soul shall be considered as having particles of “**Zero mass**”. This research further emphasize that it provides solutions to the many existing misconception in scientific theories such as origin of universe, Human ancestor, and new definition about what “**SPIRIT**” and “**SOUL**” really means.

[M.Arulmani, B.E., V.R.Hema Latha, M.A., M.Sc., M.Phil. **GOD HAS NO LUNGS? (A new theory on single chamber Heart Human)**. *Stem Cell* 2013;4(4):62-77] (ISSN 1545-4570). <http://www.sciencepub.net>.

9

Key Words: 1) Philosophy of word “**GOD**”; 2) Philosophy of word “**J-CELL**”; 3) Philosophy of “**Spirit and Soul**”; 4) Philosophy of “**Model Universe**”; 5) Philosophy of Three generation “**STEM CELL**”; 6) Philosophy of universal “**J-CODE**” (Human Life Code); 7) Philosophy of “**Creation and Evolution**”

(i)

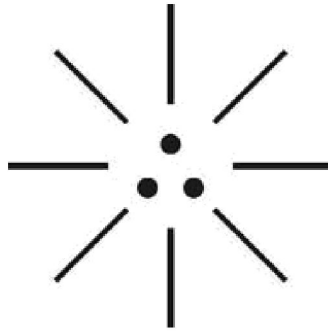
**(SPIRIT)**

(ii)

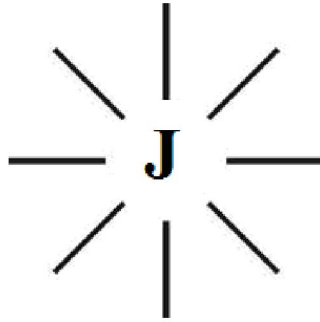
**(SOULS)**

“SPIRIT” is the source of “SOUL”. Every soul in the spectrum of souls shall be considered as distinguished “SIM” in mobile phone system. The single chamber Heart of GOD shall be considered as “Master Switching Centre”(MSC) power by Dark matter and Dark energy. Spirit is like act and soul is like rule”

- Author

1. **Introduction:**

What a wonder in the creations of God!... a minute mass of “**Embryonic cell**” becomes a “**tree of cells**” such as stem cells, Tissue cells, nervous cells, plasma cells, platelet cells, Red blood cells, white blood cells to the total count of nearly 220 types of various cells in human system and developed through process of **Cell division**.

It is focused that thousands of theories existing currently about Philosophy of “**Spirit and soul**” focused by philosophers such as **Plato, Aristotle, Socrates**, and Ancient Egyptian mythology and **various religions** etc.

In medical, Biological science, the philosophy of “**SOUL**” is not accepted as it can’t been seen through “**Electron Microscope**”. It is not understood by the author the fact that “**WHEN A CHILD WETS IN THE RAIN, MOTHER GETS FEVER WHY?**”... **Any Soul flows between them?!...**

“The soul probably can’t been seen by the human and fellow scientists who have four chambered Heart associated with Lungs.”

- Author.

2. Previous Publication:

The philosophy of origin of first life and human, the philosophy of model Cosmo Universe, the philosophy of fundamental neutrino particles have already been published in various international journals mentioned below. Hence this article shall be considered as **extended version** of the previous articles already published by the same author.

- [1] Cosmo Super Star – IJSRP, April issue, 2013
- [2] Super Scientist of Climate control – IJSER, May issue, 2013
- [3] AKKIE MARS CODE – IJSER, June issue, 2013
- [4] KARITHIRI (Dark flame) The Centromere of Cosmo Universe – IJIRD, May issue, 2013
- [5] MA-AYYAN of MARS – IJIRD, June issue, 2013
- [6] MARS TRIBE – IJSER, June issue, 2013
- [7] MARS MATHEMATICS – IJERD, June issue, 2013
- [8] MARS (EZHEM) The mother of All Planets – IJSER, June issue, 2013
- [9] The Mystery of Crop Circle – IJOART, May issue, 2013
- [10] Origin of First Language – IJIRD, June issue, 2013
- [11] MARS TRISOMY HUMAN – IJOART, June issue, 2013
- [12] MARS ANGEL – IJSTR, June issue, 2013
- [13] Three principles of Akkie Management (AJIBM, August issue, 2013)
- [14] Prehistoric Triphthong Alphabet (IJIRD, July issue, 2013)
- [15] Prehistoric Akkie Music (IJST, July issue, 2013)
- [16] Barack Obama is Tamil Based Indian? (IJSER, August issue, 2013)
- [17] Philosophy of MARS Radiation (IJSER, August 2013)
- [18] Etymology of word “J” (IJSER, September 2013)
- [19] NOAH is Dravidian? (IJOART, August 2013)
- [20] Philosophy of Dark Cell (Soul)? (IJSER, September 2013)
- [21] Darwin Sir is Wrong?! (IJSER, October issue, 2013)
- [22] Prehistoric Pyramids are RF Antenna?!... (IJSER, October issue, 2013)
- [23] HUMAN IS A ROAM FREE CELL PHONE?!... (IJIRD, September issue, 2013)
- [24] NEUTRINOS EXIST IN EARTH ATMOSPHERE?!... (IJERD, October issue, 2013)
- [25] EARLY UNIVERSE WAS HIGHLY FROZEN?!... (IJOART, October issue, 2013)
- [26] UNIVERSE IS LIKE SPACE SHIP?!... (AJER, October issue, 2013)
- [27] ANCIENT EGYPT IS DRAVIDA NAD?!... (IJSER, November issue, 2013)
- [28] ROSETTA STONE IS PREHISTORIC “THAMEE STONE” ?!... (IJSER, November issue, 2013)
- [29] The Supernatural “CNO” HUMAN?... (IJOART, December issue, 2013)
- [30] 3G HUMAN ANCESTOR?... (AJER, December issue, 2013)
- [31] 3G Evolution?... (IJIRD, December issue, 2013)
- [32] God Created Human?... (IJERD, December issue, 2013)
- [33] Prehistoric “J” – Element?... (IJSER, January issue, 2014)
- [34] 3G Mobile phone Induces Cancer?... (IJERD, December issue, 2013)
- [35] “J” Shall Mean “JOULE”?... (IRJES, December issue, 2013)
- [36] “J”- HOUSE IS A HEAVEN?... (IJIRD, January issue, 2014)
- [37] The Supersonic JET FLIGHT-2014?... (IJSER, January issue, 2014)
- [38] “J”-RADIATION IS MOTHER OF HYDROGEN?... (AJER, January issue, 2014)
- [39] PEACE BEGINS WITH “J”?... (IJERD, January issue, 2014)
- [40] THE VIRGIN LIGHT?... (IJCRAR, January issue 2014)
- [41] THE VEILED MOTHER?... (IJERD, January issue 2014)

3. Hypothesis:

1) The whole universe and Human shall be considered as created by “GOD” through billions of “**white rays**” emitted from his “**Single chamber heart**”. The white rays shall be considered as “**absolutely pure**” and heart GOD needs no lungs for purification of his **Heart**. The Spirit of God shall be considered as composed of infinite level of **Dark Matter, Dark Energy**, associated with **Dark Genome** required for creations and its sustainability of its existence.

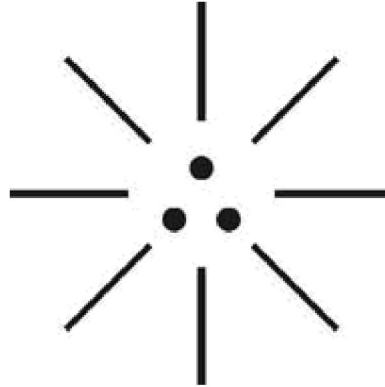
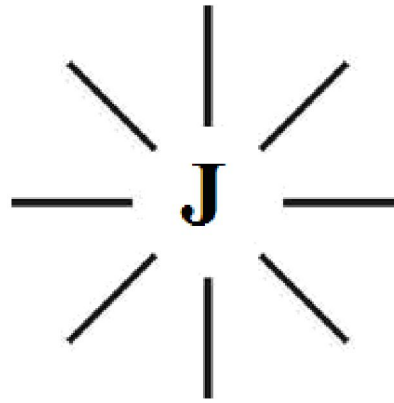
(i)**(SPIRIT)****(ii)****(SOULS)**

(iii)

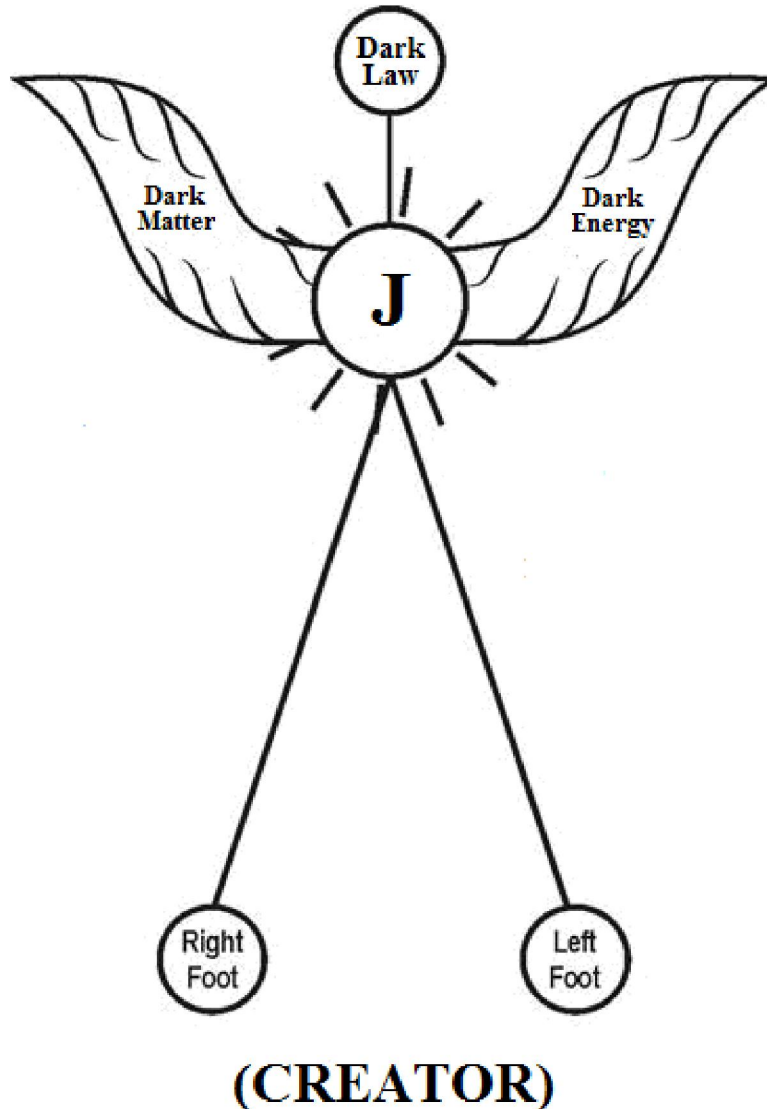

The philosophy of “**GOD**” (creator) shall be defined within the following scope.

- (i) God shall mean “**Super human**”
- (ii) God Shall mean Dark human inbuilt with “**Spirit**”
- (iii) God shall mean having “**Single chamber Heart**”
- (iv) God shall mean having “**No Lungs**”
- (v) God shall mean source of “**souls**”
- (vi) God shall mean standstill space ship containing “**cargo souls**”

2) Every ray in the “Spectrum of souls” shall be considered as composed of Trillions of cells and the smallest unit shall be considered an “Three-in one” undivided parameter called “**J-CELL**”. The Philosophy of J-CELL shall be defined within the following scope.

i) J-cell is composed of three-in-one fundamental particles photon, Electron, proton also called as God particles (or) Virgin particles. The virgin particles shall be considered as “**absolutely pure and white**”.

ii) J-cell shall mean most fundamental cell of the life and non-life matter having “**Zero mass**”. The particles shall be considered as displaced symmetrically by an angle of “**120°**” each other. The

philosophy of various life cells such as Stem cells, Blood cells, tissue cells etc. shall be considered derived from the most fundamental “**J-cell**”.

iii) J-cell shall mean having sustained oscillation having defined polarity.

iv) J-cell shall mean having three-in-one fundamental **Electric, Magnetic, Optic** property required for sustainability of life system under equilibrium condition.

v) J-cell shall mean having defined “**gender**” characteristics such as male, female, dual.

3) The entire “**Cosmo Universe**” created by GOD shall be considered composed of **Three-in-one** distinguished regions separated by thin transparent membrane called “**VEIL**” (Cosmo barrier). VEIL shall mean tissue like membrane as in the case of “**CELL WALL**” in Biological science, and like barrier in between so called Ionosphere, stratosphere in **astrophysics**. The base of Cosmo universe shall mean having the foundation of **SUN, EARTH, MOON**. Alternatively the whole Cosmo universe shall be considered like GOD in “**Stand still position**”. His “**BELLY**” (Region III) shall be considered as **material universe** where are planets, matters consider exists.

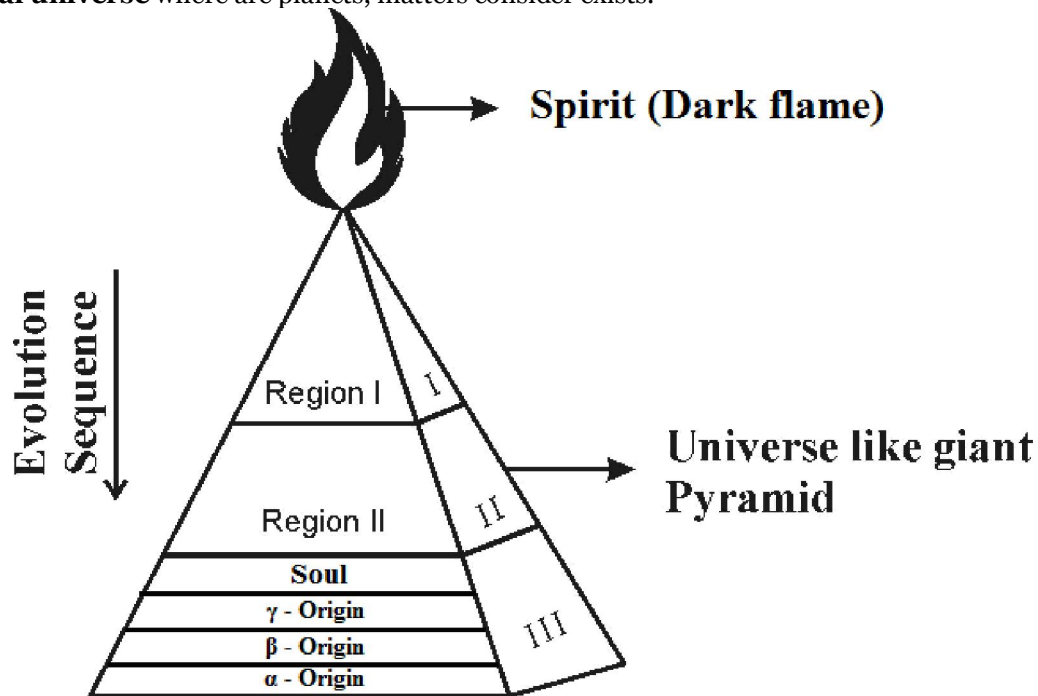

(3G EVOLUTION)

4) The first human created by God shall be considered as “**Human Ancestor**”. The human ancestor shall be considered having only “**Three chromosome**” on origin having single chamber heart and without lungs. Further the human Ancestor considered having only single blood type AB with only “**PLASMA**”. In **three nuclear age of expanding universe** three human types with different “Genetic Structure” considered as evolved. **CREATION** is like origin; **EVOLUTION** is like journey. The four type blood with sub elements plasma, platelet, red blood cells, white blood cells with **associated lungs** shall be considered as pertains to 3rd generation human populations.

- | | | |
|--|---|----------------------------|
| i) Human with single chamber heart
having No lungs | - | on creation |
| ii) Human with single chamber heart
having No lungs | - | 1 st generation |
| iii) Human with three chamber heart
with lungs | - | 2 nd generation |
| iv) Human with four chamber heart
with lungs | - | 3 rd generation |

5) It is hypothesized that the structure of “**stem cells**” shall be considered variant in three nuclear age as stipulated below.

- i) “J-cell” - “Stem tree of creation”
 ii) Single chamber heart with no lungs - stem of 1st generation
 iii) Three chamber heart with lungs - stem of 2nd generation
 iv) Four chamber heart with lungs - stem of 3rd generation

The above “four type of stem cell” shall be considered as pertain to four distinguished “families of stem cells” of J-Cells i.e. Creation alpha family, Beta family, Gamma family.

4. Hypothetical Narration

a) **Spirit differs from soul?...**

In general many believe that both these words shall commonly means something invisible and immortal that exists inside human, and during death this invisible part of a human **leaves the body and lives on**. Without spirit the body is considered as deed. Scientists generally treat soul as poetic synonym for “mind”.

It is focused that the words spirit, soul shall be considered as having scientific relation, spirit shall be considered as “**ENERGY**” and soul shall be considered as “**FORCE**”. Spirit shall be considered as the source of soul. No spirit shall mean no soul. Spirit is like Jhangri; Soul is like Smile.

In cosmological, Astronomical aspects spirit shall be referred to “Dark Home” shall be composed of full of “**Antineutrinos**”. **Soul** shall be considered as neutrinos directly opposite to the characteristics of Antineutrinos. Soul shall also be called as “**virgin light**” (or) “**white flame**” which shall be considered as the “**centromere**” of material universe. In other words all the created matters shall be considered as created souls in Equilibrium status under the “**spirit**” irrespective of the matter whether is Organic (or) non-organic.

(i)

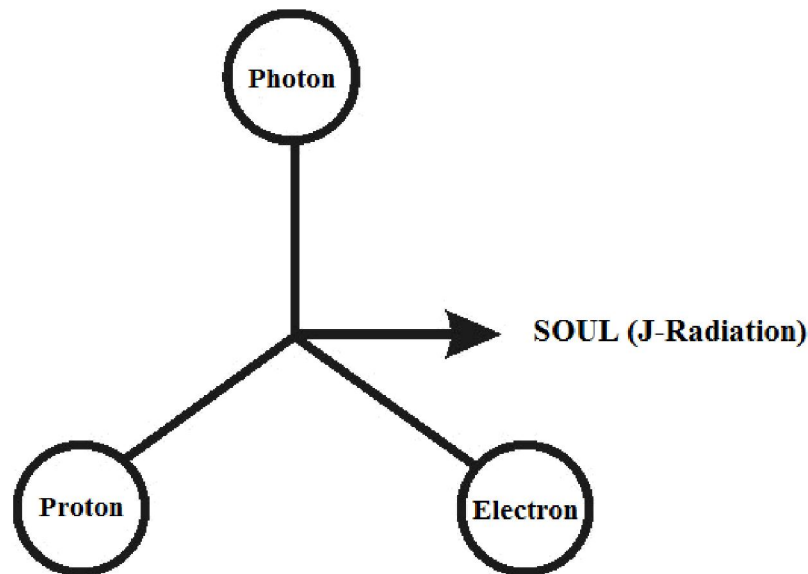

(NEUTRINO OSCILLATION)

(ii)

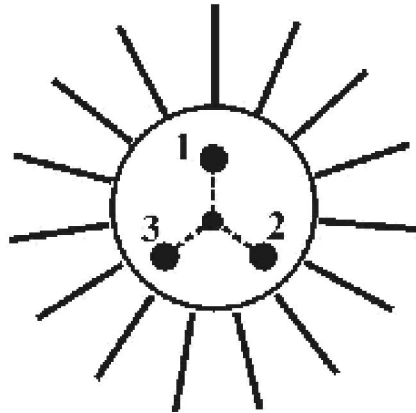

1. **Dark Genome**
2. **Dark Energy**
3. **Dark Matter**

(SPIRIT)

b) **Philosophy of Spirit, soul in Human Science?...**

In Human Science, medical science the concept of existence of soul is not accepted by the scientists. It is focused that in the chronological event of child growth within the mother's womb, the "**soul**" shall be considered as the located within every human as a source of "**Driving force**" from Embryo stage to fully grown up child. The specific location point of "Soul" within 'the human' shall considered results in initiation of "**heart beat**" in the fetus. No soul shall mean "No heart beat". The heart beat pulse of human shall be considered closely associated with natural frequency of oscillation of "fundamental Neutrinos" as stipulated in the Hypothesis.

In the expanding universe the created human soul shall be considered as evolved to different genetic characteristics due to gradual increase in "**CELL MASS**" of Human. Due to this reason the **standard Heart beat** rate of human in three generations shall be considered variant say ...

- | | | |
|---------------------------------|---|--------|
| i) 1 st generation | - | 60 ppm |
| ii) 2 nd generation | - | 70 ppm |
| iii) 3 rd generation | - | 80 ppm |

It is focused that the variant in standard heart beat rate might have a paved situation for evolving "**additional chambers**" in Human Heart say...

- | | | |
|---------------------------------------|---|------------------------------|
| i) 1st generation | - | single chamber with no lungs |
| ii) 2nd generation | - | three chamber with lungs |
| iii) 3rd generation | - | four chamber with lungs. |

It is further emphasized that in the growth of child within the mothers womb the following types of cells shall be considered as evolved at different stages as follows:

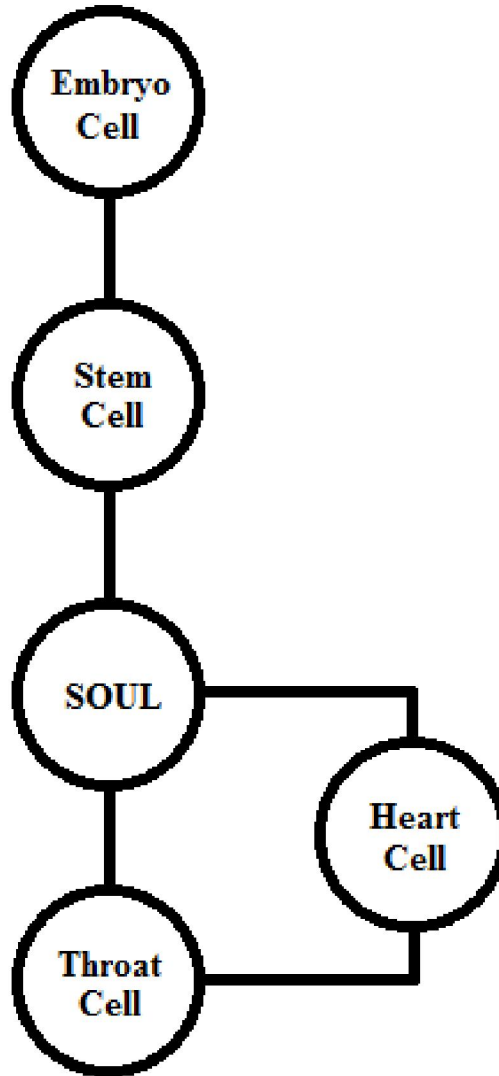

(Hypothetical Chronology)

- | | | |
|----------------------|-----------------|-----------------------|
| i) Embryonic cell | - | origin |
| ii) Stem cell | - | 1 st stage |
| iii) J-Cell (Soul) - | 2 nd | stage |
| iv) Heart cell | - | 3 rd stage |
| v) Lungs cell | - | 4 th stage |

It is focused that before birth of child “**stem cell**” shall be considered the **source of Energy (Spirit)** for the soul to function. After birth “**Lungs cell**” shall be considered as the source of energy deriving **OXYGEN** through respiration through “**Nostrils**”. Hence stem cell (umbilical cord) shall be cut off from the system and no longer required.

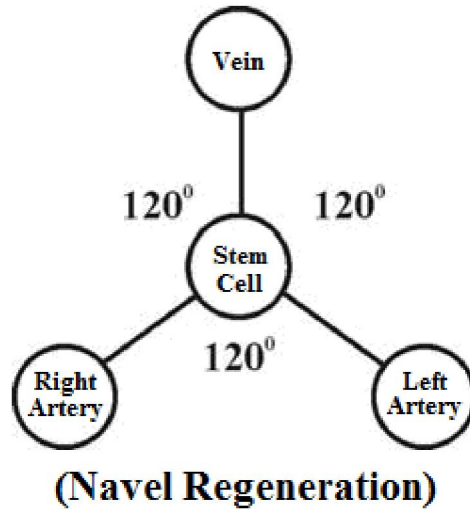

It is focused that “**Soul Point**” shall be considered as existing at the specified location. The soul point shall be considered as the centromere and integral part of Chest Nipples and Navel (Stem cell). The soul point of every human shall be called as human life code (J-Code).

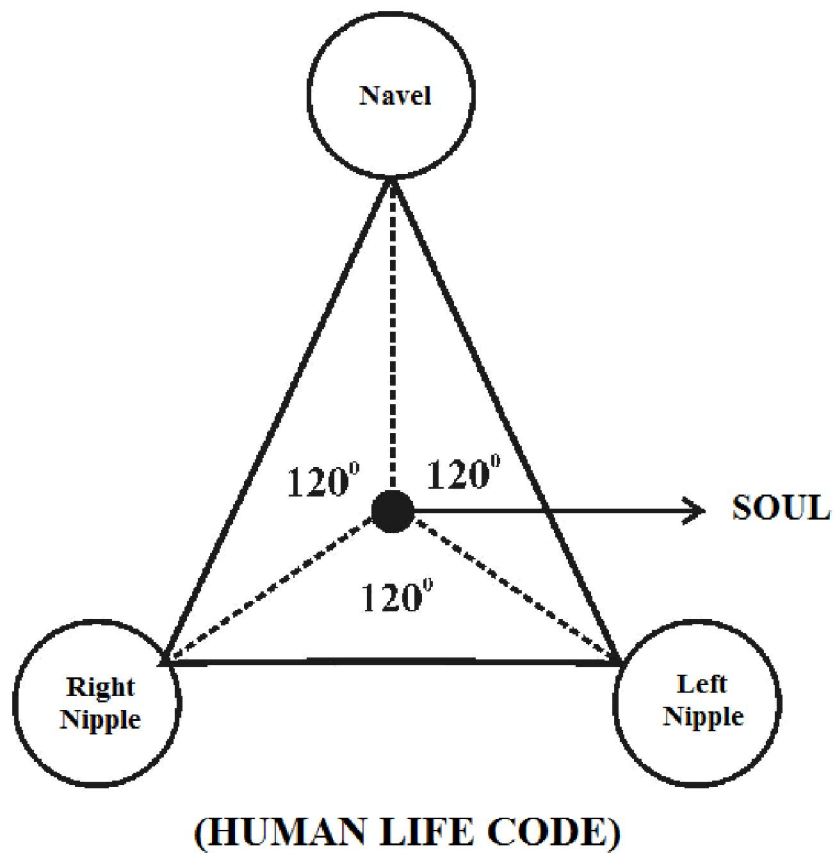

- i) Right Nipple - Responsible for functional part of Human system.
- ii) Left Nipple - Responsible for structural part of Human system
- iii) Navel (Stem cell) - Energy source
- iv) Soul - Driving force of Human system

The “**Throat**” shall be considered as the integral part of **Lungs**, Brain and Heart of the human system.

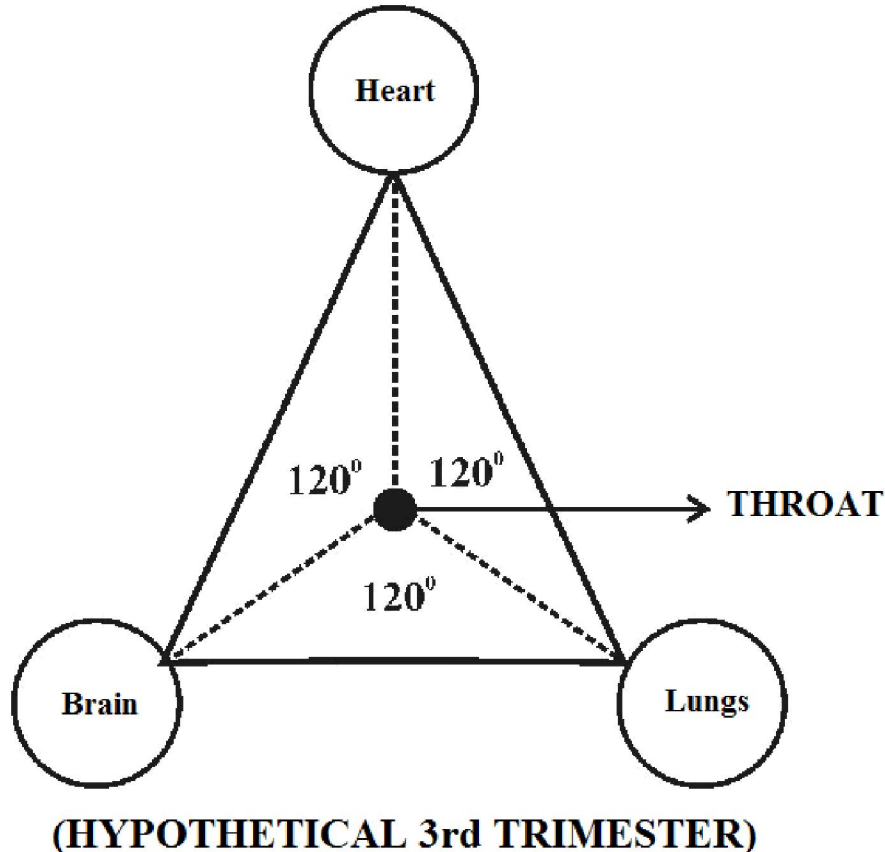

c) Heart transplant affect soul point?...

It is focused that the soul point shall be considered as the distinguished location from the Heart cell region. The soul point of human shall not be affected even heart is totally removed from the human and substituted with artificial **PACE MAKER**.

d) 1st human origin had navel?...

As the first human was created by GOD, through “soul” (J-Radiation) the first human might not have had navel on origin.

e) 1st generation human had Ozone breath?...

It is focused that the 1st generation human with single chamber heart might have had “**Ozone**” Breath. Ozone shall be considered as absolutely pure, compared to Oxygen, which necessitated for no need of Lungs.

f) Human soul have weight?...

Case study shows that in 1901 Dr. Duncan Mac Dougall made weight measurements of the six patients when died. He claimed that there was an average reduction of “**21 grams**” before and after death of persons.

It is focused that every soul shall be considered having definite negligible mass. During death the cells (J-cell) at the “**soul point region**” shall be considered as diffused which result in reduction in loss in weight of the person after death. But it is focused that the average weight of the soul shall be considered as low in earlier generations. Say

- | | |
|--|------------|
| i) 1 st generation weight - | 10 grams |
| ii) 2 nd generation weight- | 15 grams |
| iii) 3 rd generation weight | - 21 grams |

g) Case study on “Stem cell”, “Lung cell”

(i) The recent research reveals that the pulmonary vasculatures, the blood vessels that connect the heart to the lung, develops even in the “absence of the Lung”.

- Science daily July 21, 2013.

(ii) Recent research focus that scientists invent particles that will let human live without breathing. Research shows that the designed micro particles that can be injected directly into the blood stream to quickly oxygenate the human body even it cannot breathe anymore. It is believed that this medical science break through may save millions of life in future. Boston children hospital claimed that human can exist 15 to 30 minutes despite major respiration failure.

- Latest Research

h) Case study on Bible?...

From the Biblical understanding the “**HEAVENLY FATHER**” might have had “**Single Chamber Heart**”. He might not have required “**LUNGS**” as the God was filled with “**HOLY SPIRIT**”.

(i)

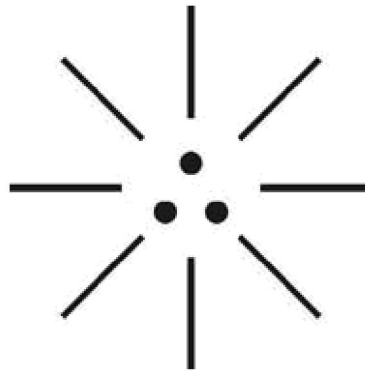

(SPIRIT)

(ii)

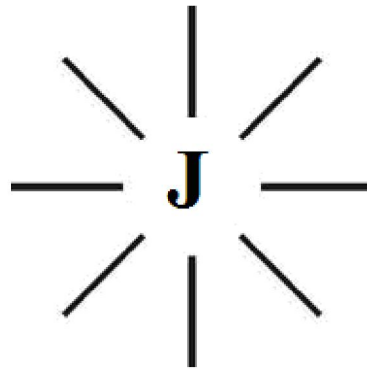

(SINGLE CHAMBER HEART)

The Holy spirit shall be considered as the source of “**SOULS**”. God might have created Billions of souls through his **Holy Spirit** emitted from “**Holy Heart** “. Holy Spirit shall be defined with in the scope.

(i) Holy Spirit shall mean having “**Creation effect**”.

(ii) Holy Spirit shall mean composed of fundamental particles photon, Electron, proton having “**Zero mass**” and absolutely pure and white.

- (iii) Holy spirit shall mean composed of Billions of souls under one Holy family called “**LORD FAMILY**”



The philosophy of “SIN” shall be defined as the gaining of gradual mass added to the fundamental particle. Each “Soul” shall be considered as having different level of “Mass” (or) different level of SIN.

It is focused that in the expanding universe under “Three Nuclear age” the initially created Human populations might have gradually gained Mass in their “CELLS” and might have undergone major three genetic change under three new families.

- (i) Lord family - Initial creation
- (ii) Angel family - 1st generation
- (iii) Tribe family (NOAH) - 2nd generation
- (vi) Christ family - 3rd generation

The three generation of population might have had variant “**Stem cells**” and variant Heart structure which shall be hypothetically narrated as bellow.

- (i) **Heavenly Father**
(GOD) - Single chamber Heart without Lungs with Plasma radiation.
- (ii) **Angels**
(1st generation) - Single chamber Heart without Lungs.
- (iii) **Noah origin**
(2nd generation) - Three chamber Heart with Lungs.
- (iv) **Jesus Christ**
(3rd generation) - Four chamber Heart with Lungs.

“ADAM, EVE population shall be considered belong to “Angel family”. After consumption of forbidden fruit Adam, Eve might have acquired additional chamber in Heart and become genetically varied”

- **Author**

It is focused that the philosophy of word “CHRIST” in Bible shall be considered as “Family name” of 3rd generation population. Christ family shall be considered as the “First family” in 3rd generation. The Christ family shall be considered composed of “Virgin Father”, “Virgin mother”, “Virgin son” in three-in-on configuration of “virgin Christ family”. In christ family the four chambered heart father, mother, son shall be considered connected to “SIGNLE CHMBER HEART”.

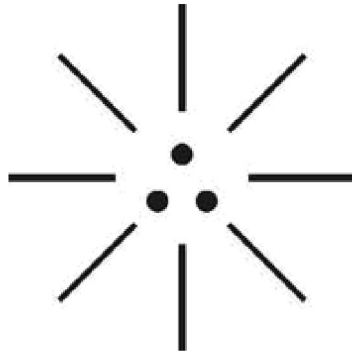

(DIVINE FAMILY)

- i) Father is like “PHOTON”
- ii) Mother is like “ELECTRON”
- iii) Son is like “PROTON”

“AVE MARY shall mean mother mary covered with absolutely pure white “Holy spirit” and view like “White VEIL”, “VEIL MARY” shall also mean “HOLY SPIRIT”

- **Author**

It is focused that in the “Divine plan” of God, Father, Mother, Son can never be separated and considered as “Three-in-one” God (or) “TRINITY”.

- i) Father is like “Spirit”
- ii) Mother is like “Bread”
- iii) Son is like “Blood”

“In Passover feast (Eucharist) the Priest shall be considered as “Images of Jesus” and offering “Holy Manna Food” to all the participants of the church irrespective of caste, creed, religion, church denomination to get liberation from “Evil Spirit” and inspired with “New Hope of Life”. Jesus came to save all so that no one is lost. The holy water of mass shall be sprinkled among all and the holy manna food shall be offered among all.

- **Author**

i) Case study on Human Anthropology?...

Base on world history and anthropological science the stipulated various races of Human populations “Angels”, “Dravidians”, “Aryans” shall be considered as pertain to three different family and genetically varied.

- i) **Angels** (1st generation) – Single chamber heart without lungs
- ii) **Dravidian** (2nd generation) – Three chamber heart with Lungs
- iii) **Aryans** (3rd generation) – Four chamber heart with lungs

j) Chera, Chola, Pandya had three chamber Heart?...

It is focused that Chera, Chola, Pandya populations shall be considered as lived before “Jesus Christ” and considered as three major “ethnic group” of ‘Dravidians’.

“Dravidian shall mean three chamber Heart with Lungs”

-
Author

k) Thiruvalluvar had three chamber Heart?...

It is focused not only Thiruvalluvar, Buddher, Moses, King Davind, Jews, Asokar, Alexander, Akbar all might have made only three chamber heart with lungs.

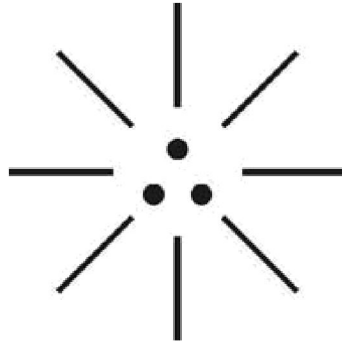

(THREE CHAMBER HEART)

- | | | |
|---------------------|---|--------------|
| i) Right Chamber | - | PORUL |
| ii) Left Chamber | - | INBAM |
| iii) Centre Chamber | - | ARAM |

l) Aristotle had three chamber heart?...

Case study shows that Aristotle considered human heart to be three chamber or “TRIVENTRICLE” which consists of right ventricle, atrium, left ventricle. It is focused that Aristotle might have had only three chamber heart associated with lungs.

5. CONCLUSION:

It is focused that in the early universe the universe and all matters, life shall be considered as created by GOD. During the course of time the created matter shall be considered have undergone three major genetic changes in three geological, nuclear age also called as “TRIASSIC”. Human was created and evolved. (ie) The single chamber heart without lungs become evolved into four chamber heart with lungs. The four type human blood might be evolved subsequently from single type blood “AB”.

“The first generation “AB” type blood shall be considered like “PLASMA STATE”

- **Author**

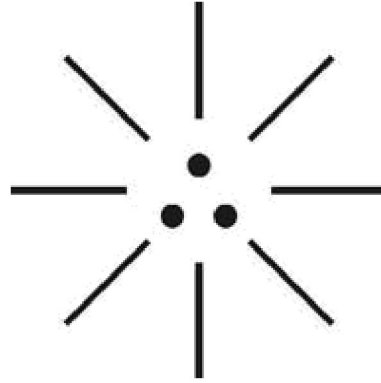

(TRIASSIC)

6. REFERENCE

7. Intensive Internet “e-book” study through, Google search and wikipedia
8. M.Arulmani, “3G Akkanna Man”, Annai Publications, Cholapuram, 2011
9. M. Arulmani; V.R. Hemalatha, “Tamil the Law of Universe”, Annai Publications, Cholapuram, 2012
10. Harold Koontz, Heinz Weihriah, “Essentials of management”, Tata McGraw-Hill publications, 2005
11. M. Arulmani; V.R. Hemalatha, “First Music and First Music Alphabet”, Annai Publications, Cholapuram, 2012
12. King James Version, “Holy Bible”
13. S.A. Perumal, “Human Evolution History”
14. “English Dictionary”, Oxford Publications
15. Sho. Devaneyapavanar, “Tamil first mother language”, Chennai, 2009
16. Tamilannal, “Tholkoppiar”, Chennai, 2007
17. “Tamil to English Dictionary”, Suravin Publication, 2009
18. “Text Material for E5 to E6 upgradaton”, BSNL Publication, 2012
19. A. Nakkiran, “Dravidian mother”, Chennai, 2007
20. Dr. M. Karunanidhi, “Thirukkural Translation”, 2010
21. “Manorama Tell me why periodicals”, M.M. Publication Ltd., Kottayam, 2009
22. V.R. Hemalatha, “A Global level peace tourism to Veilankanni”, Annai Publications, Cholapuram, 2007
23. Prof. Ganapathi Pillai, “Sri Lankan Tamil History”, 2004
24. Dr. K.K. Pillai, “South Indian History”, 2006
25. M. Varadharajan, “Language History”, Chennai, 2009
26. Fr. Y.S. Yagoo, “Western Sun”, 2008
27. Gopal Chettiar, “Adi Dravidian Origin History”, 2004
28. M. Arulmani; V.R. Hemalatha, “Ezhem Nadu My Dream” - (2 Parts), Annai Publications, Cholapuram, 2010
29. M. Arulmani; V.R. Hemalatha, “The Super Scientist of Climate Control”, Annai Publications, Cholapuram, 2013, pp 1-3

12/24/2013